

Lecture Series 4  
Cellular Membranes

# Reading Assignments

- Read Chapter 11  
Membrane Structure
- Review Chapter 12  
Membrane Transport
- Review Chapter 15 regarding  
Endocytosis and Exocytosis
- Read Chapter 20 (Cell Junctions)  
pages 709-717 2<sup>nd</sup> edition  
pages 700-709 3<sup>rd</sup> edition

# Selective and Semi-permeable Barriers

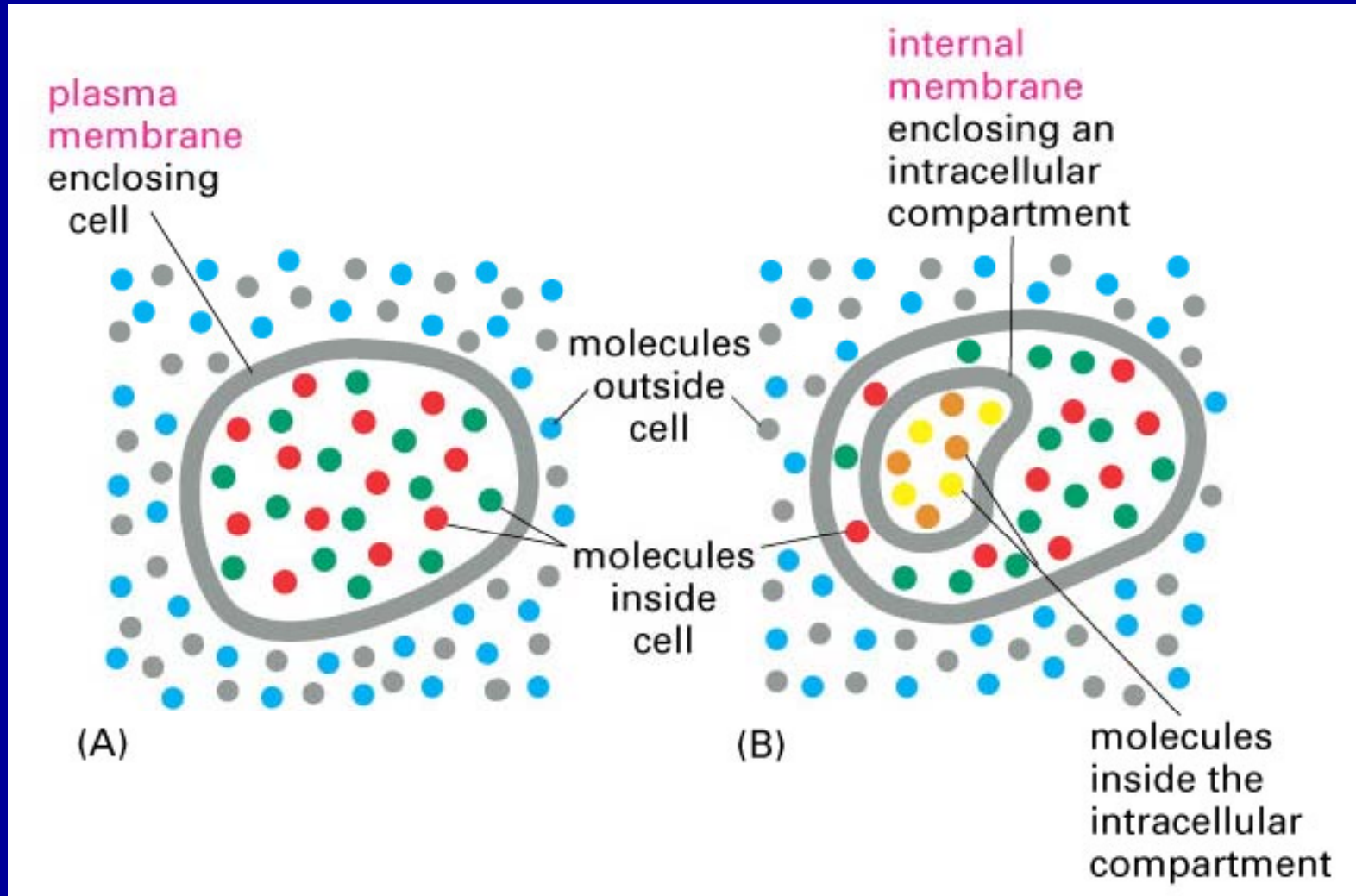

# A. Membrane Composition and Structure

- Biological membranes consist of lipids, proteins, and carbohydrates. The **fluid mosaic model** describes a phospholipid bilayer in which membrane proteins move laterally within the membrane.
- Phospholipids are the **most abundant** lipid in the plasma membrane and **amphipathic**, containing both hydrophobic and hydrophilic regions.

# *The Fluid Mosaic Model*

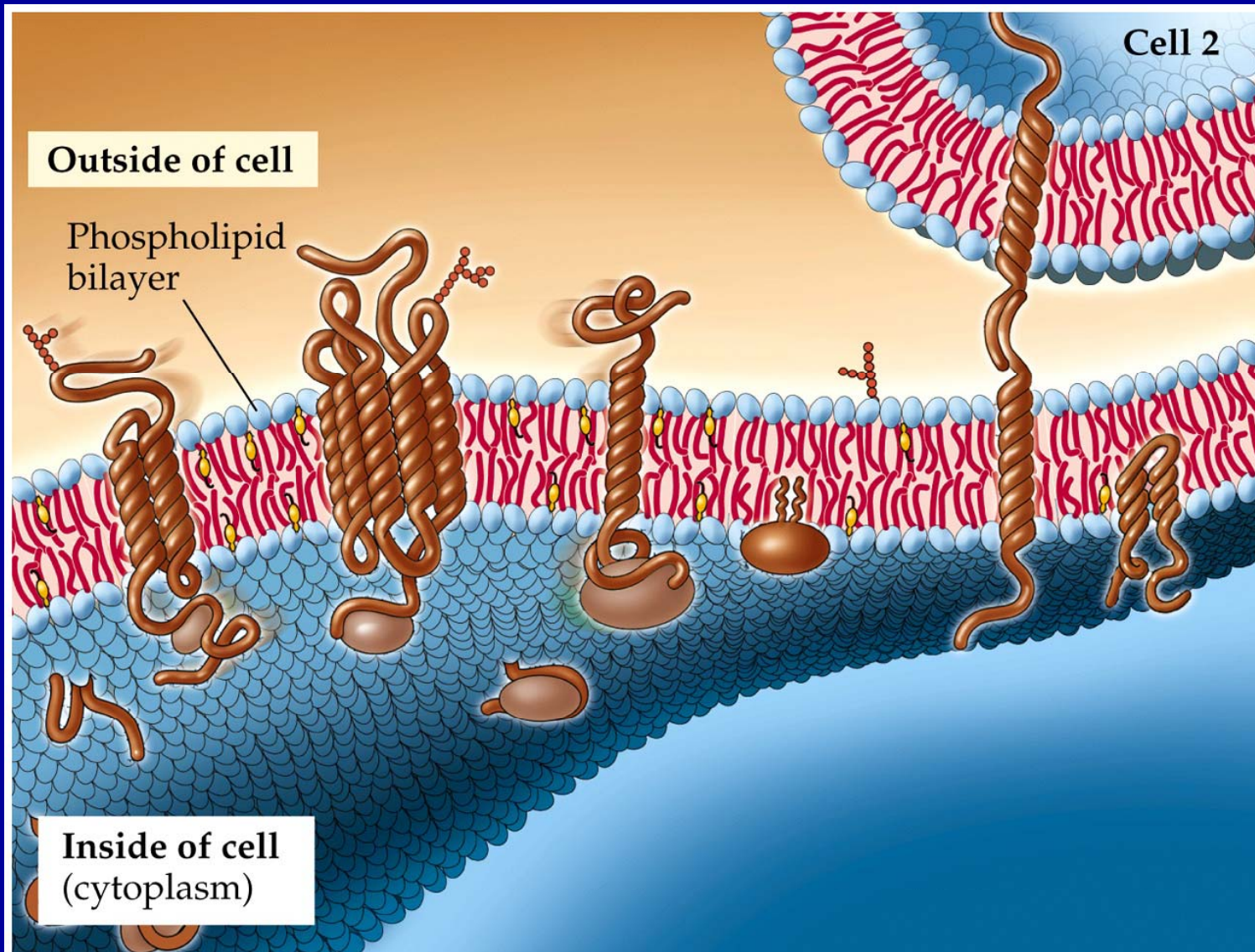

# A. Membrane Composition and Structure

- Cell membranes are bilayered, dynamic structures that:
  - ◆ Perform vital physiological roles
  - ◆ Form boundaries between cells and their environments
  - ◆ Regulate movement of molecules into and out of cells
- The plasma membrane exhibits selective permeability.
  - ◆ It allows some substances to cross it more easily than others

# *A Phospholipid Bilayer Separates Two Aqueous Regions*

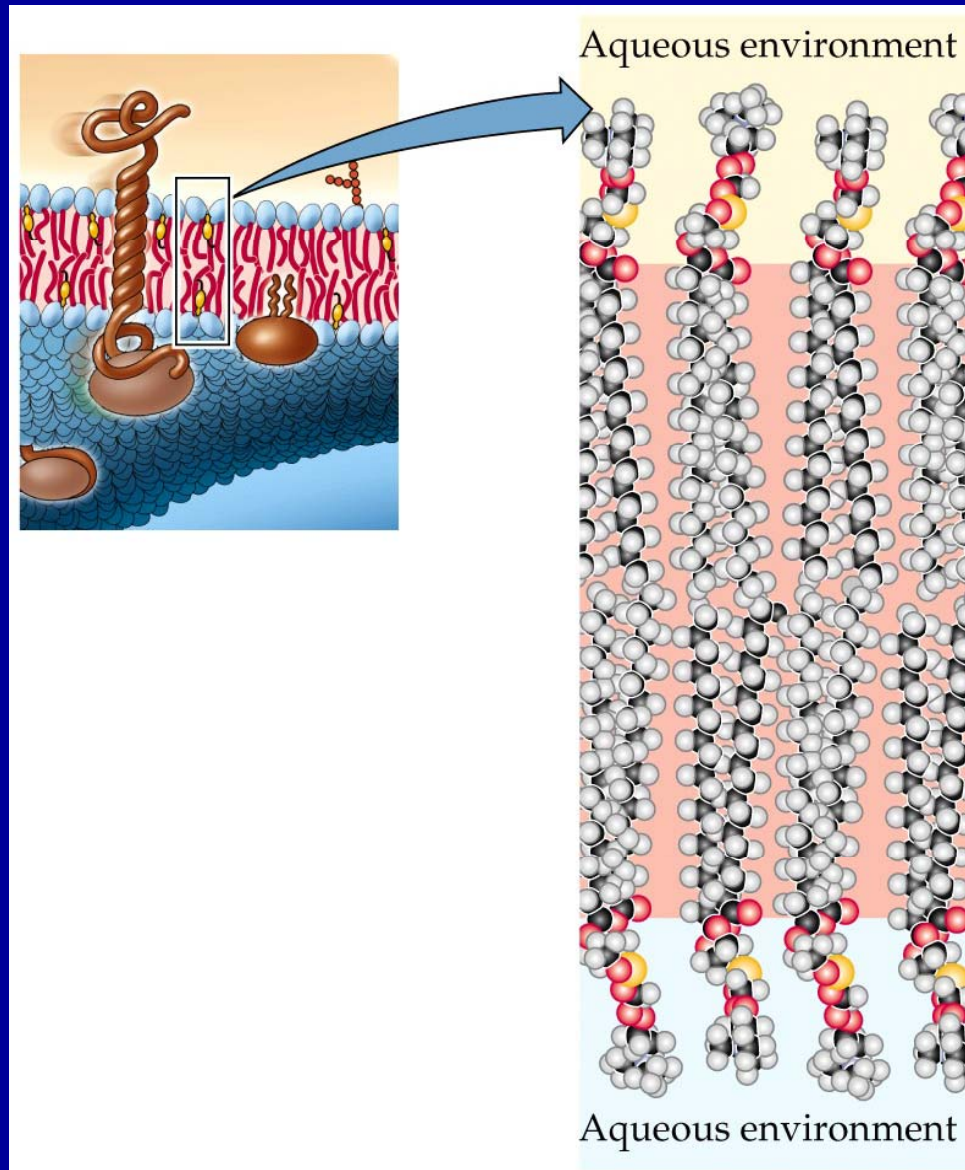

# A. Membrane Composition and Structure

- The lipid portion of a cellular membrane provides a barrier for water-soluble molecules.
- Membrane proteins are embedded in the lipid bilayer.
- Carbohydrates attach to lipid or protein molecules on the membrane, generally on the outer surface, and function as recognition signals between cells.



# A. Membrane Composition and Structure

- All biological membranes contain proteins.
- The ratio of protein to phospholipid molecules varies depending on membrane function, which can vary greatly.
- Many membrane proteins have hydrophilic and hydrophobic regions and are therefore also amphipathic.

- Davson-Danielli's Sandwich Model of membrane structure (1935):
  - ◆ Stated that the membrane was made up of a phospholipid bilayer sandwiched between two protein layers.
  - ◆ Was supported by electron microscope pictures of membranes.

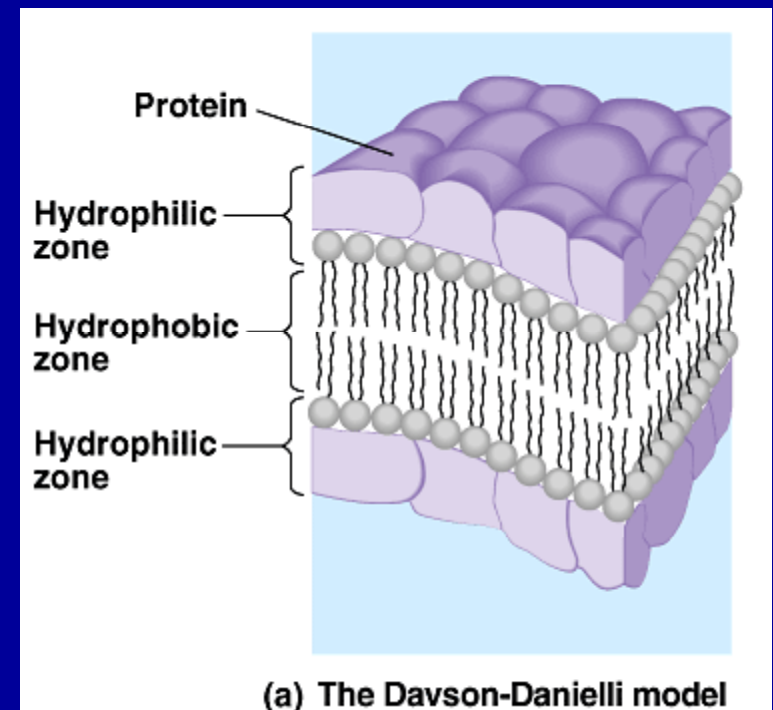

- Singer and Nicolson's Fluid Mosaic Model (1972):
  - ◆ Proposed that membrane proteins are dispersed and individually inserted into the phospholipid bilayer.

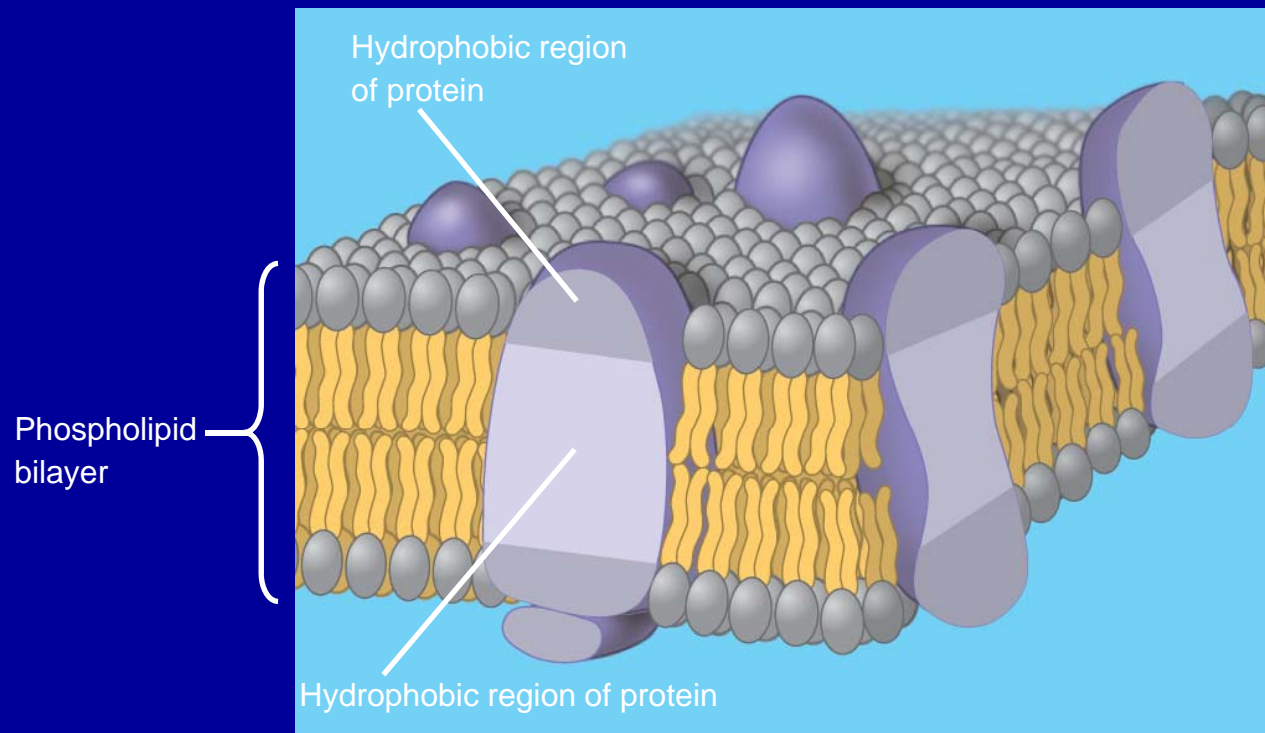

- Freeze-fracture experimentation provided evidence for the Singer-Nicolson model of membrane structure (embedded proteins than spanned membrane).
- Additional evidence when different cells are fused and the migration of membrane proteins are observed.

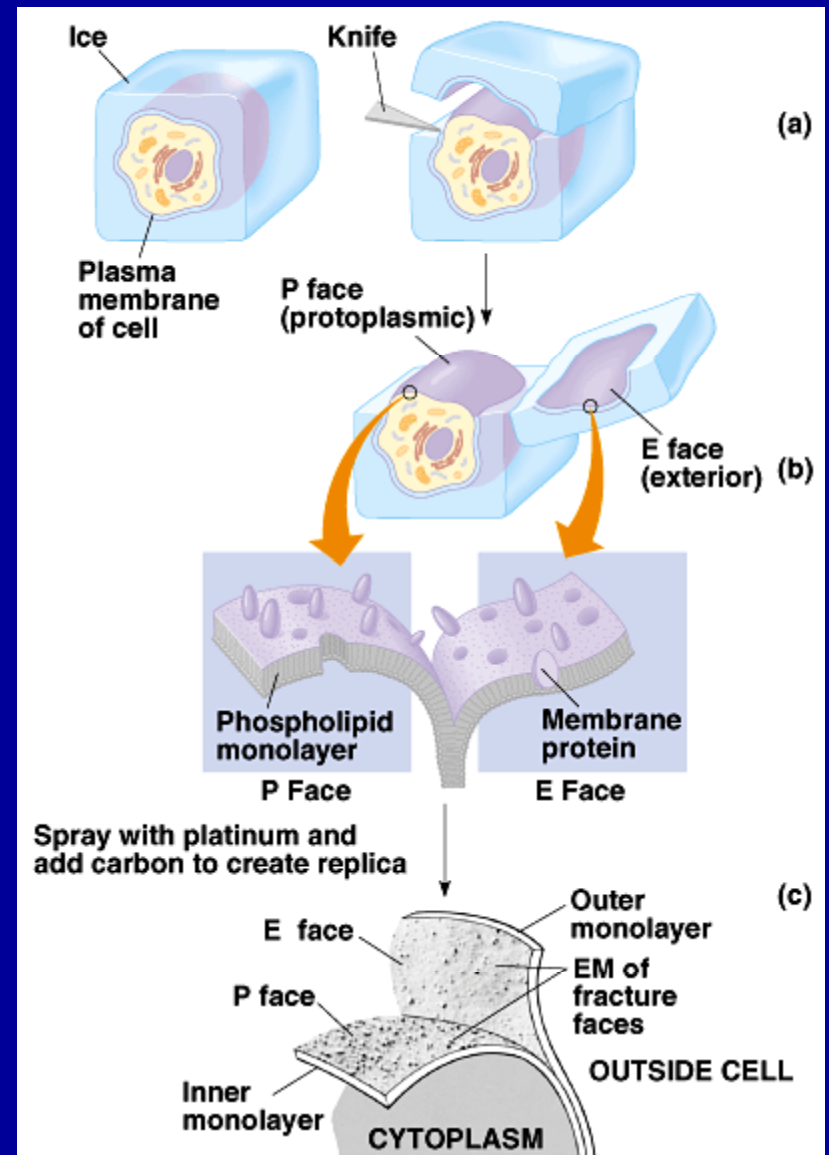
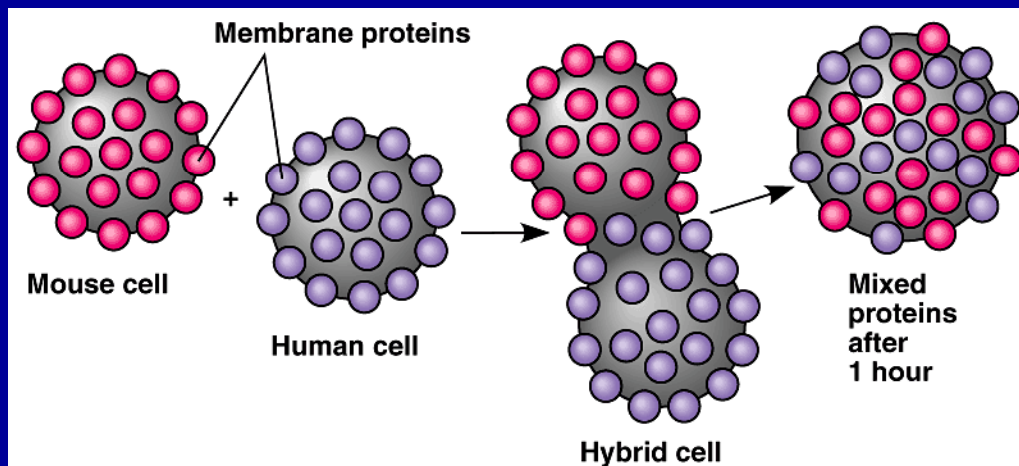

- Phospholipids are free to move laterally but flip-flop (transmembrane rotation) only rarely.
- Unsaturation (double bonds) kink tails of fatty acids and prevent orderly stacking. Thus saturated phospholipids are less "fluid" than unsaturated phospholipids.
- Cholesterol distorts the tails and generally stiffens cell membranes.

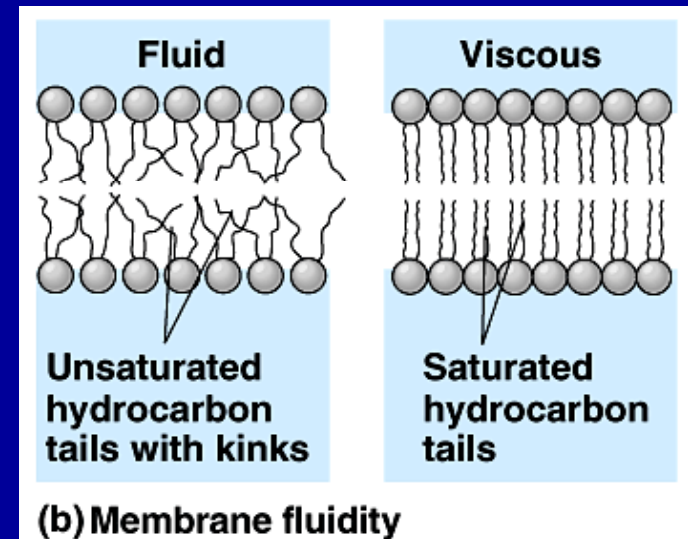
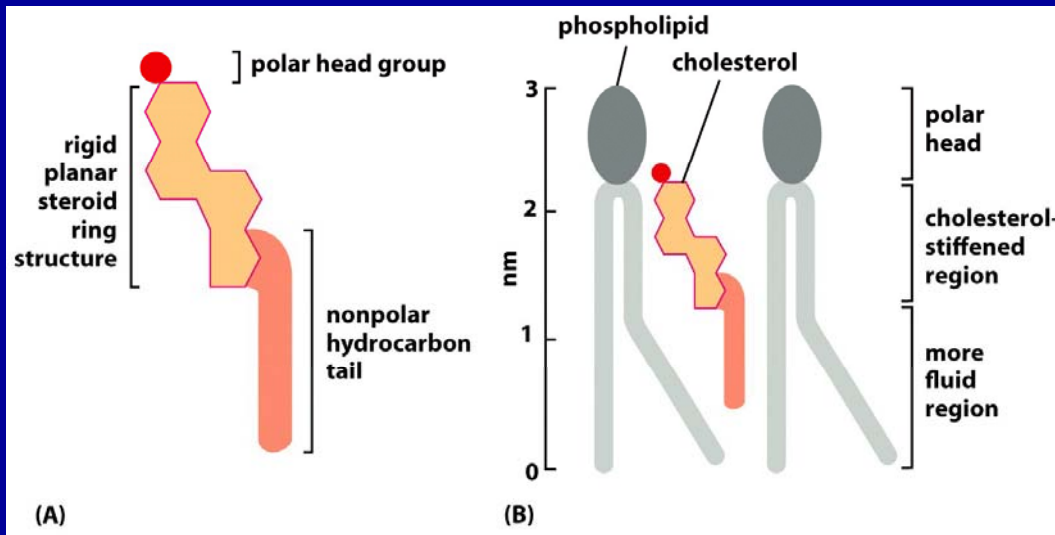
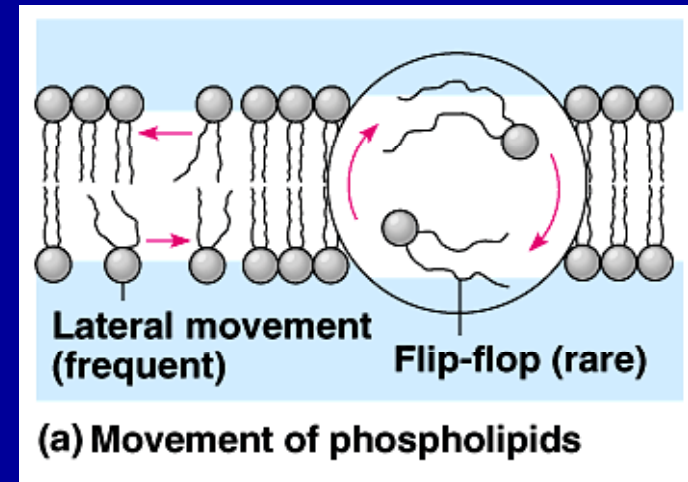

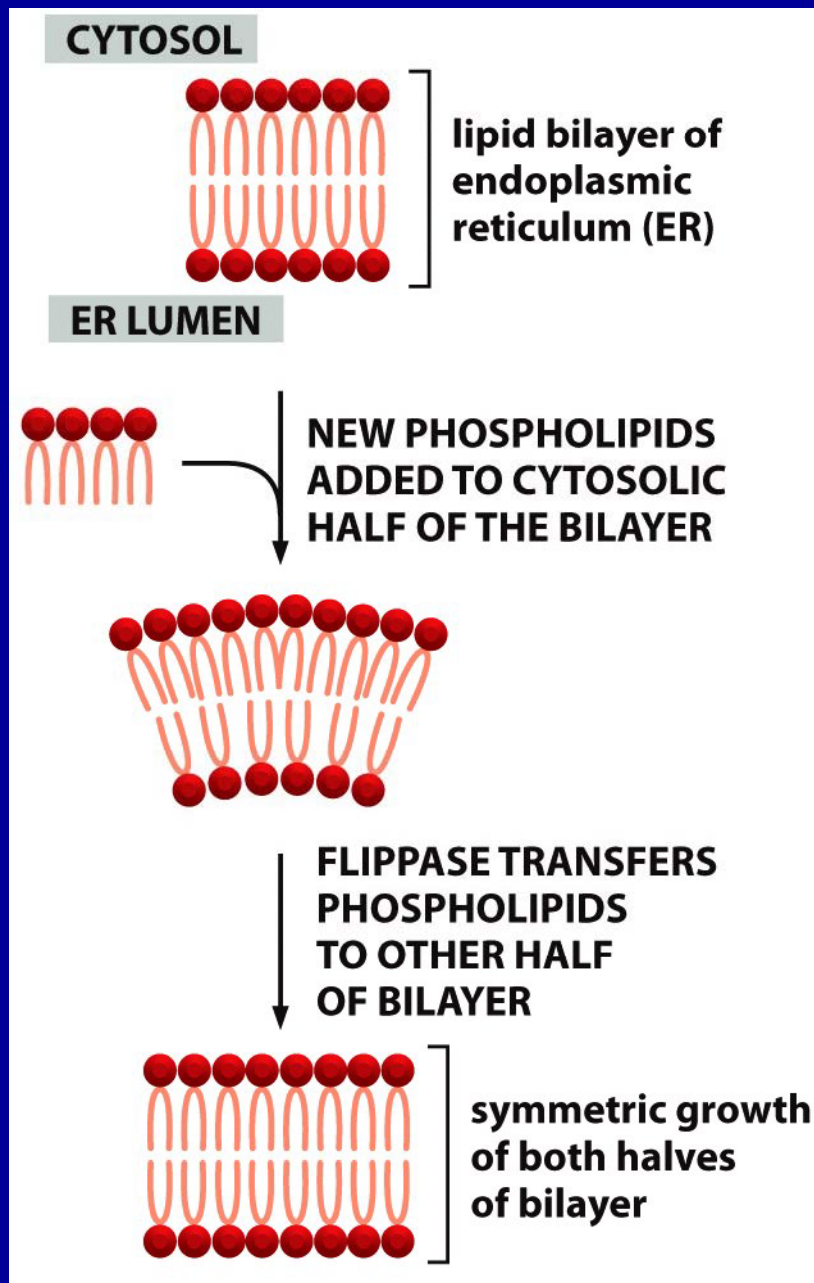

- ER is where phospholipids get synthesized and added to the endomembrane system.
- Flippases play a needed role.
- Transport vesicles resupply cellular membrane.

# Cell membranes are dynamic!

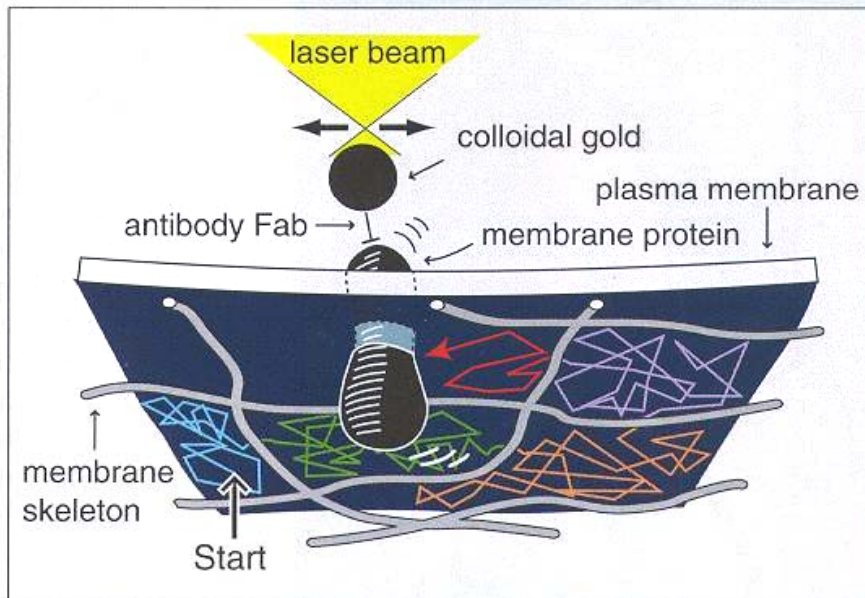

By observing and manipulating the movement of membrane receptors at the level of single molecules, membrane-skeletal organization of the plasma membrane is being elucidated.

- Live Camera Action! Beads the size of molecules are conjugated with a fluorescent tag that lipids like to hang onto...
- Individual paths of lipids as they moved through the membrane can then be tracked

# Cell membranes are dynamic!

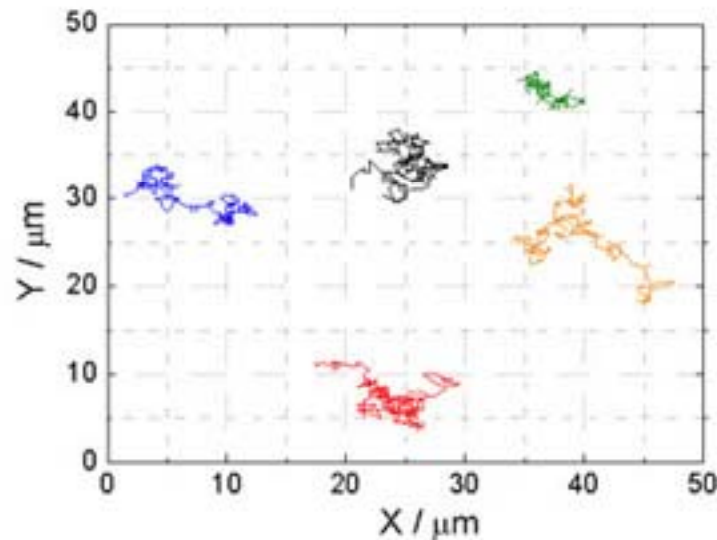
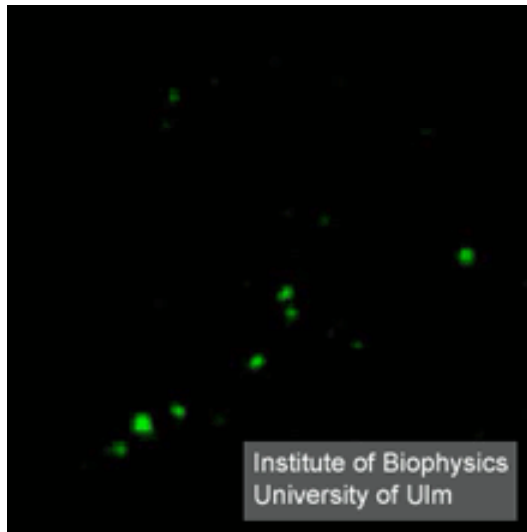

- Live Camera Action! Beads the size of molecules are conjugated with a fluorescent tag that lipids like to hang onto...
- Individual paths of lipids as they moved through the membrane can then be tracked



# FRAP

## Fluorescence Recovery After Photobleaching

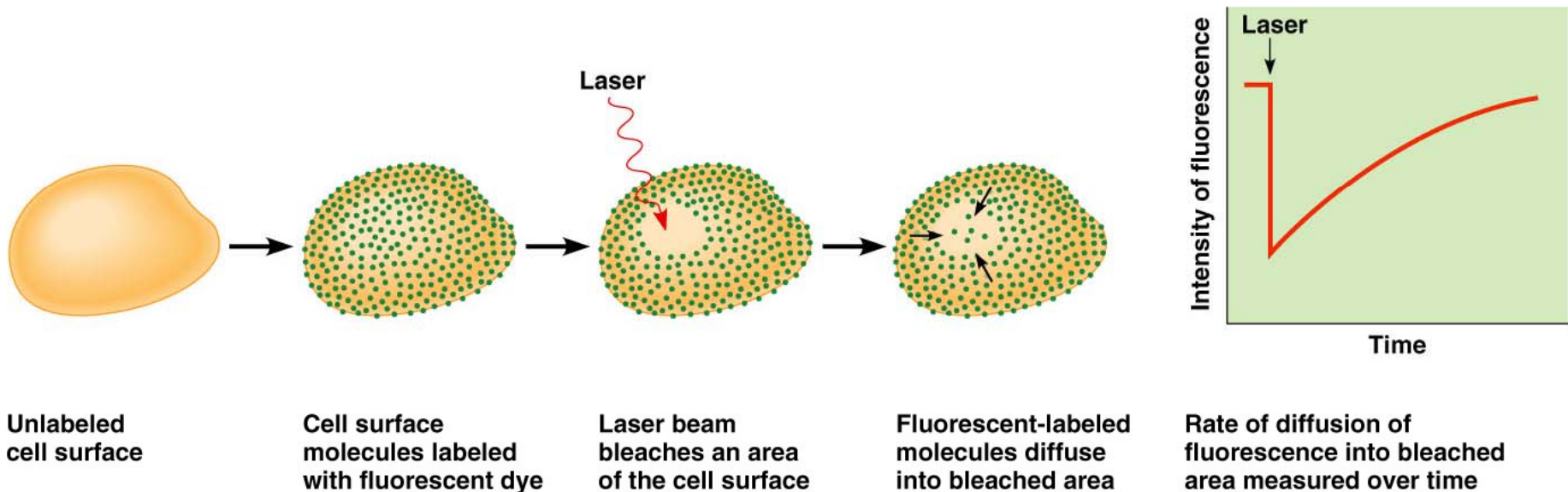

Label protein of interest with fluorescent tag, photobleach (burn out) with a laser and *time* how long it takes for burn out to recover

# Lipid asymmetry

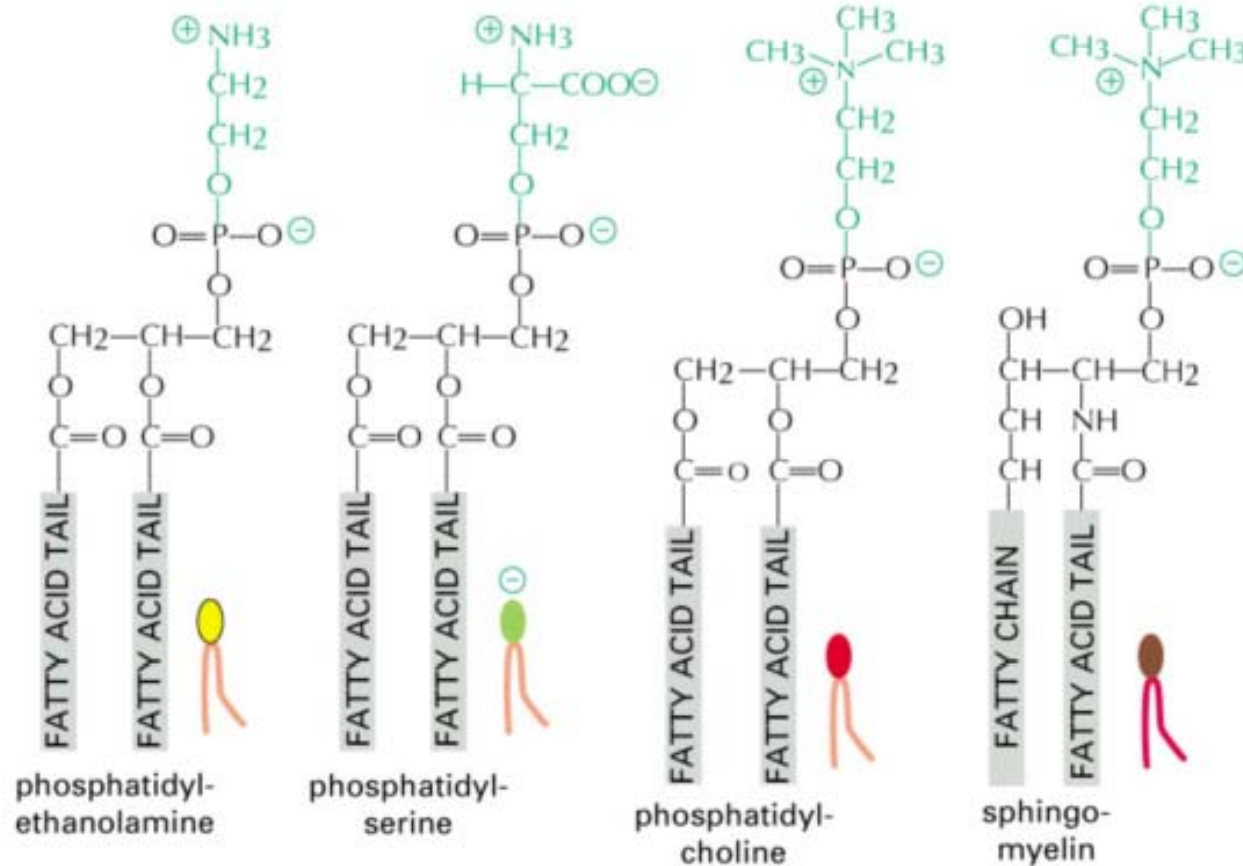

# Lipid asymmetry

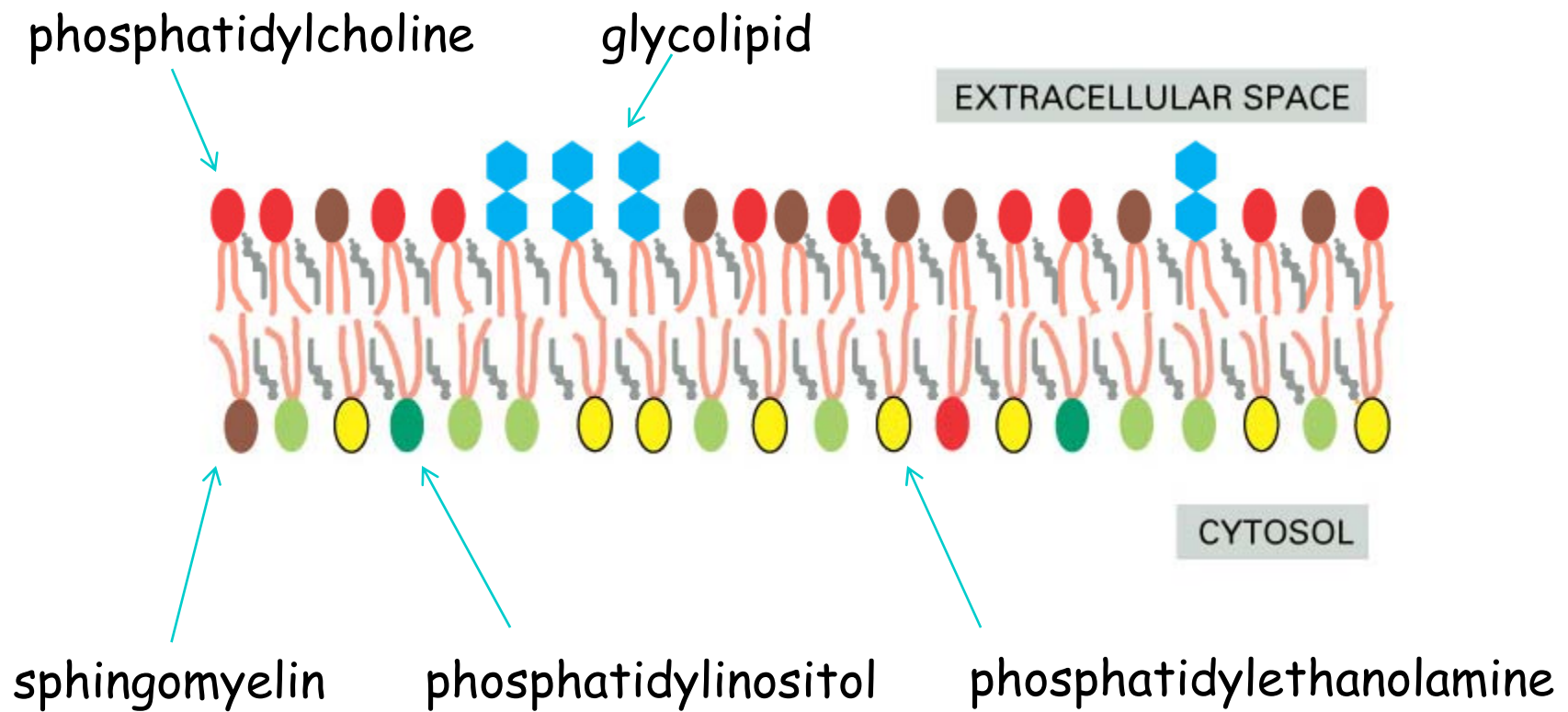

# Lipid asymmetry

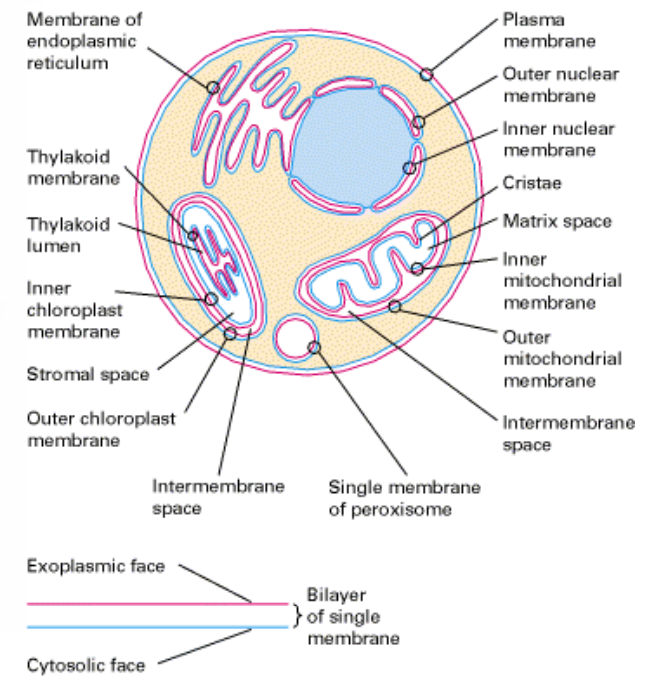
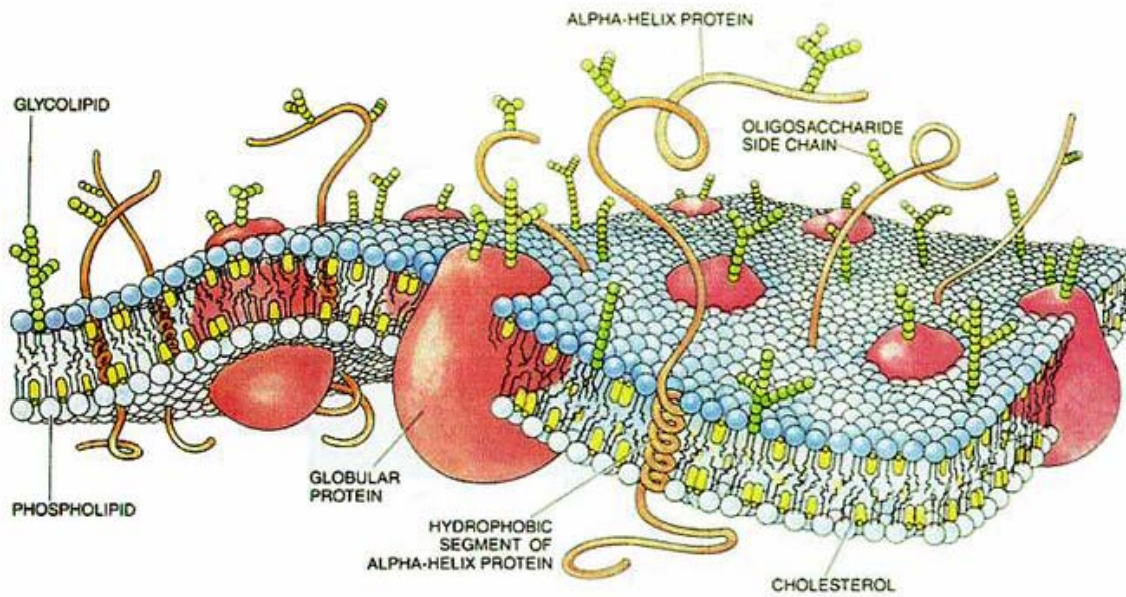

# A. Membrane Composition and Structure

- Integral membrane proteins are partially inserted into the phospholipid bilayer. Peripheral proteins attach to its surface by ionic bonds.
- The association of protein molecules with lipid molecules is not covalent; both are free to move around laterally, according to the fluid mosaic model.

# *Interactions of Integral Membrane Proteins*

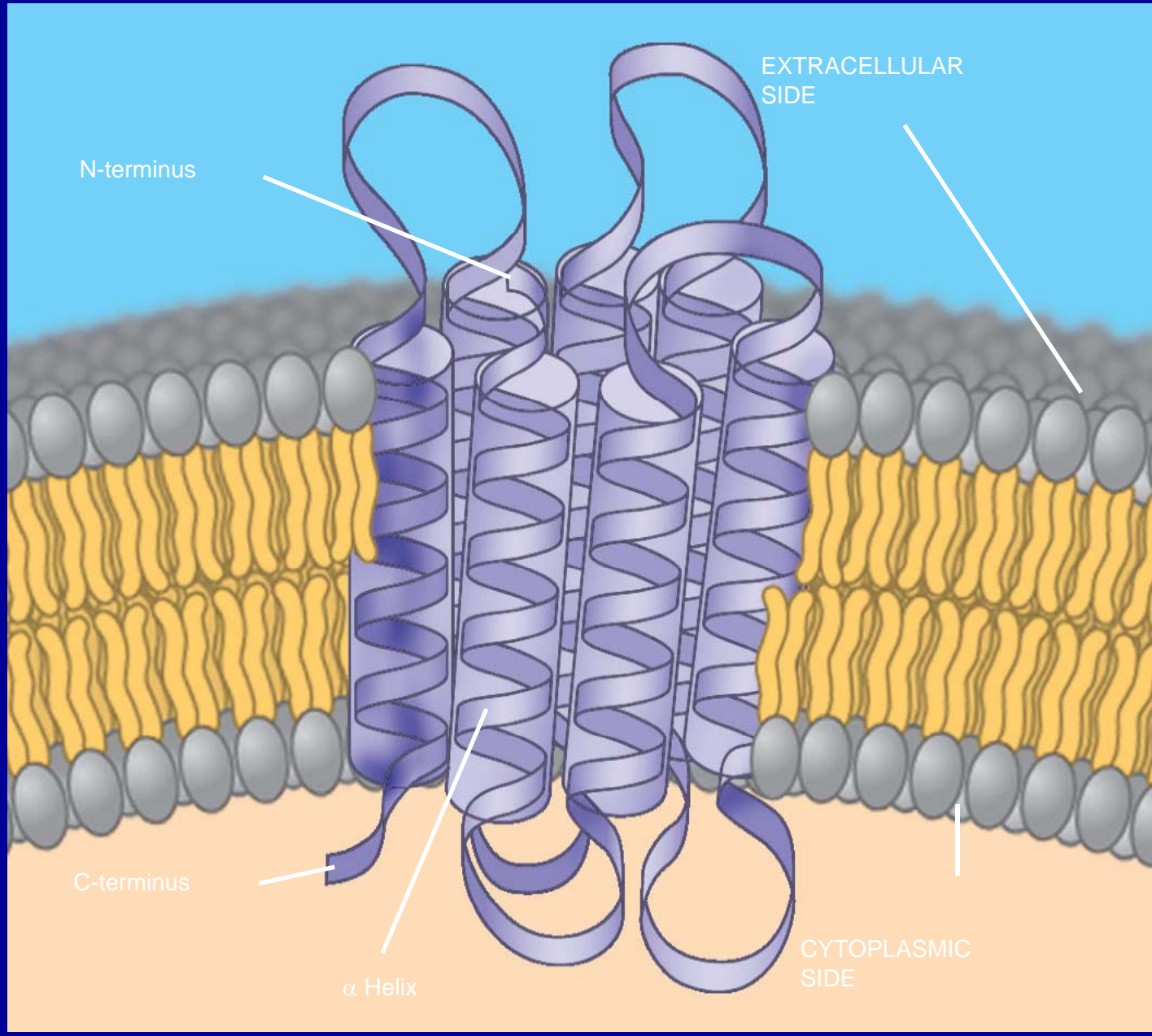

# A. Membrane Composition and Structure

- **Integral membrane proteins** have hydrophobic regions of amino acids that penetrate or entirely cross the phospholipid bilayer.
  - ◆ **Transmembrane proteins** have a specific orientation, showing different "faces" on the two sides of the membrane.
- **Peripheral membrane proteins** lack hydrophobic regions and are not embedded in the bilayer.

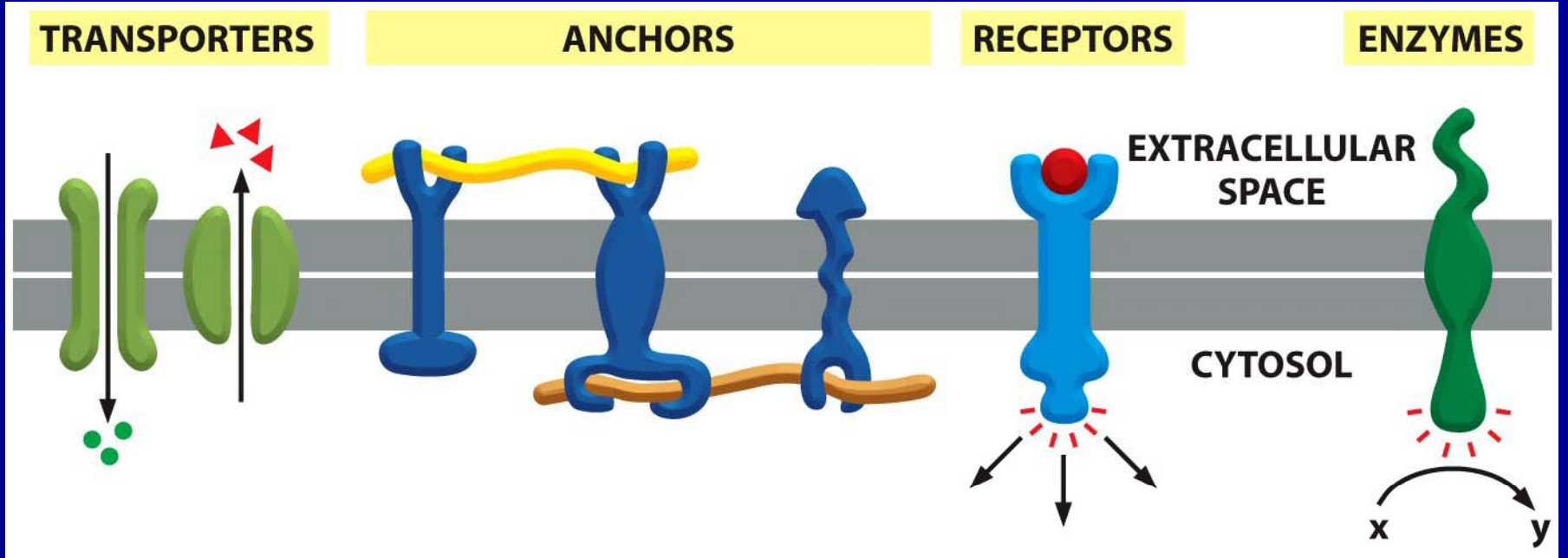

Integral or transmembrane proteins play several different roles in a cell. Each of these distinctive proteins is encoded by a particular gene and thus has a very specific amino acid sequence.



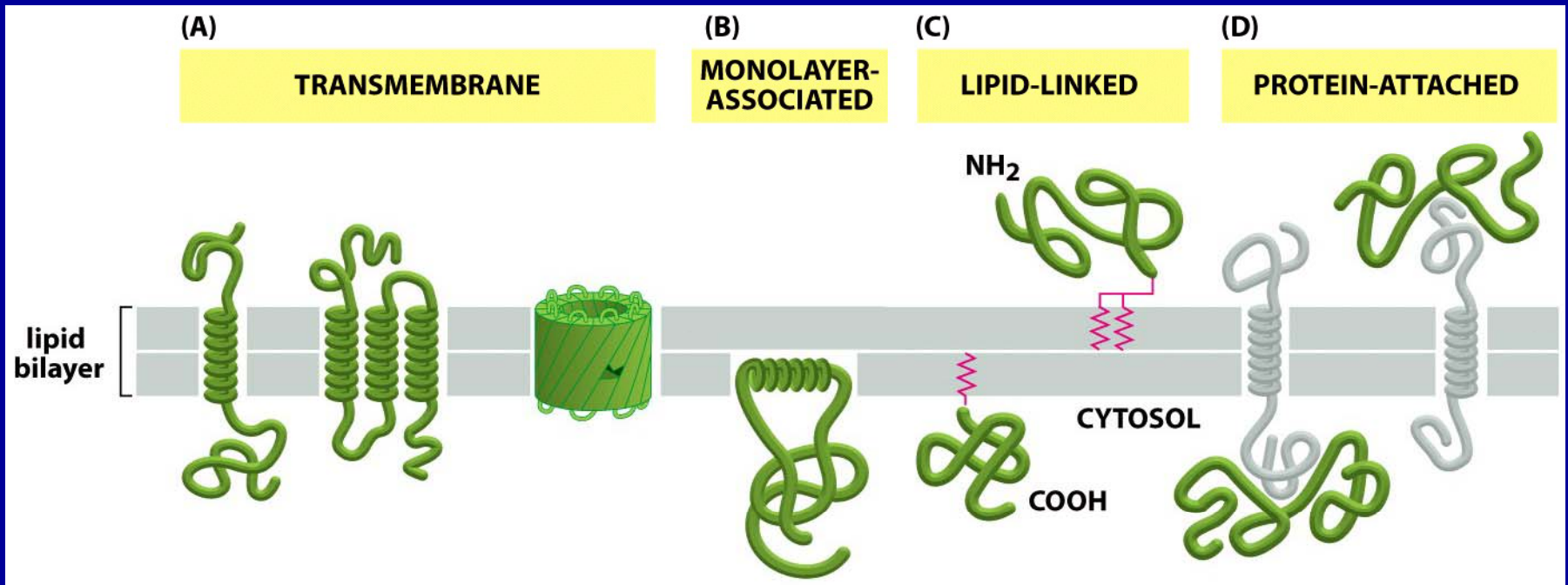

Membrane proteins can associate with the lipid bilayer in several different ways.

# How to make a strong membrane: spectrins in RBCs

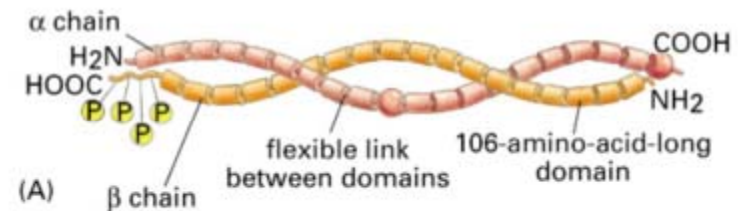
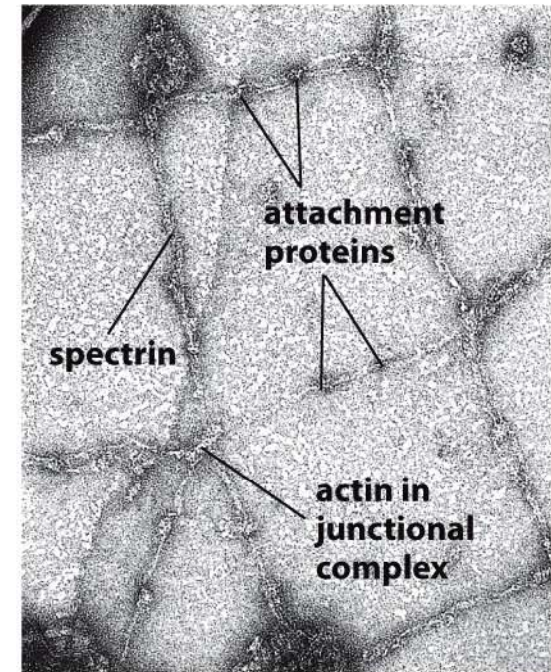
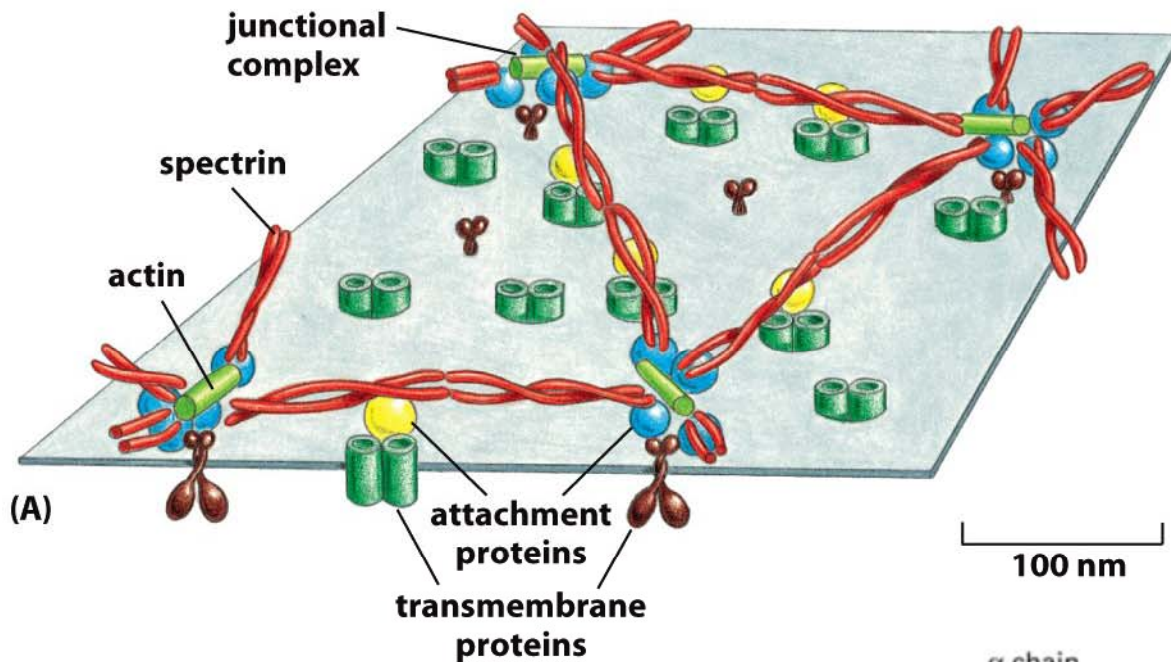

# How to make a strong membrane: spectrins in RBCs

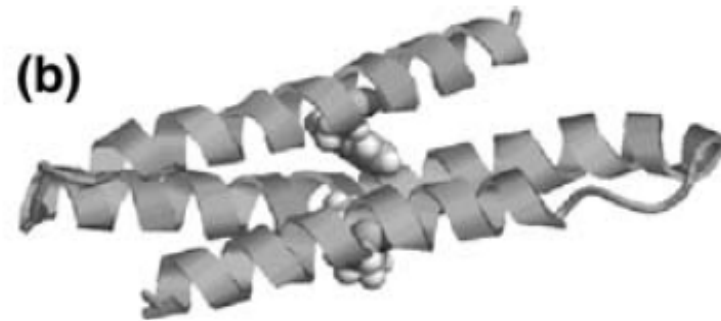
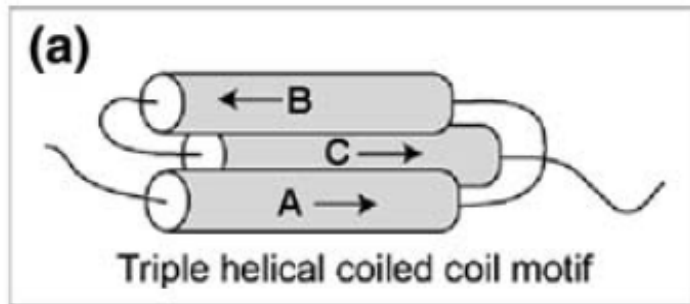

# B. Disrupting Membranes

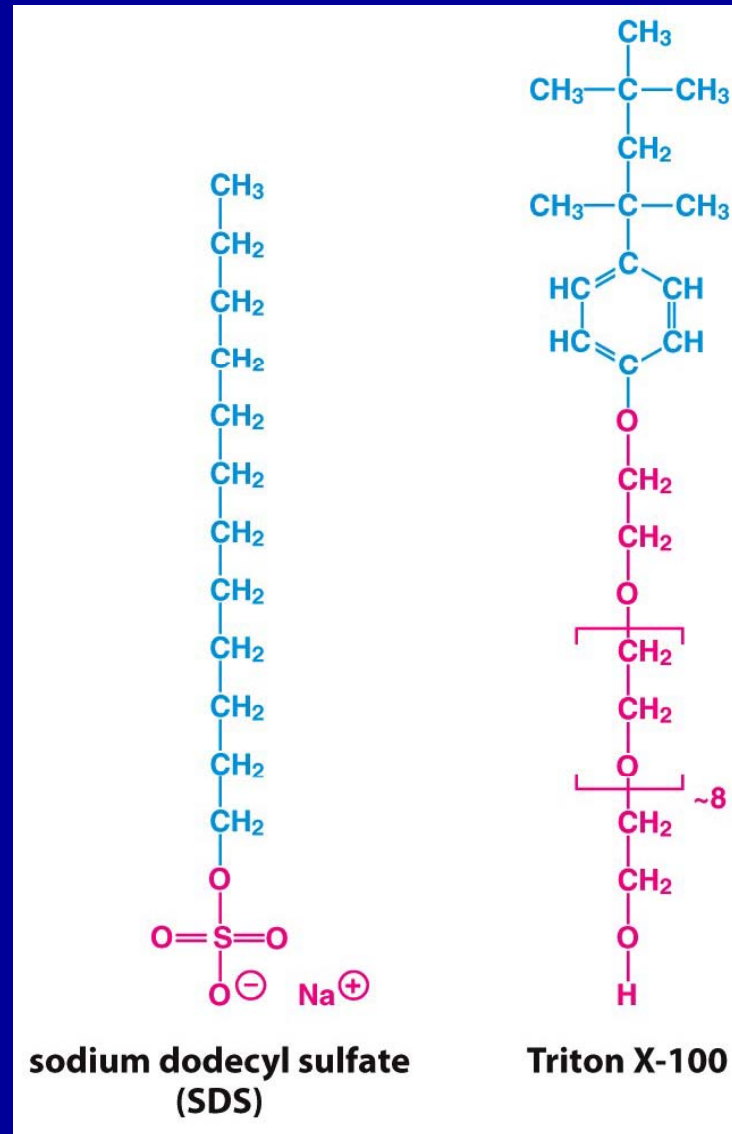

# Detergents vs. lipids

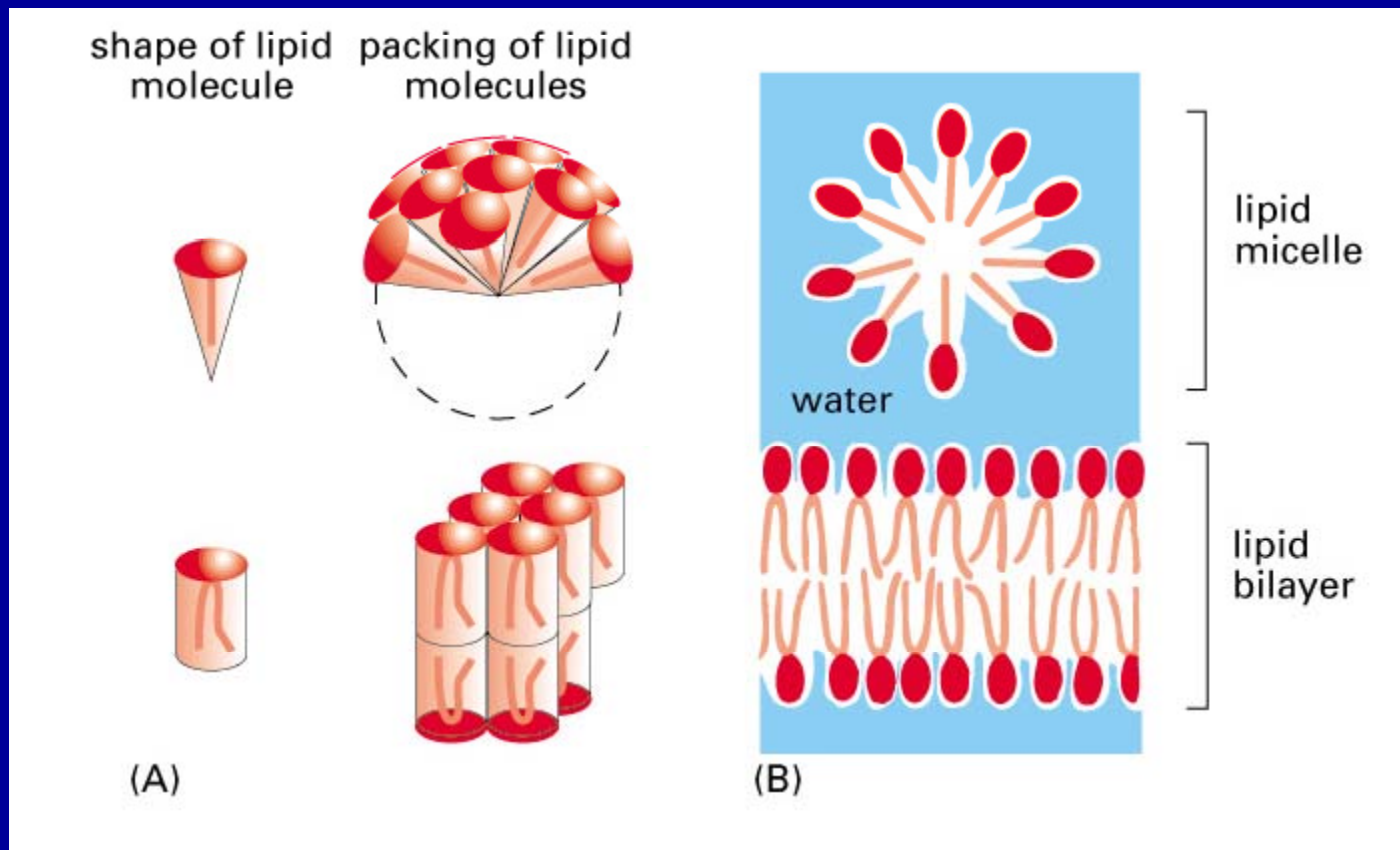

# B. Disrupting Membranes

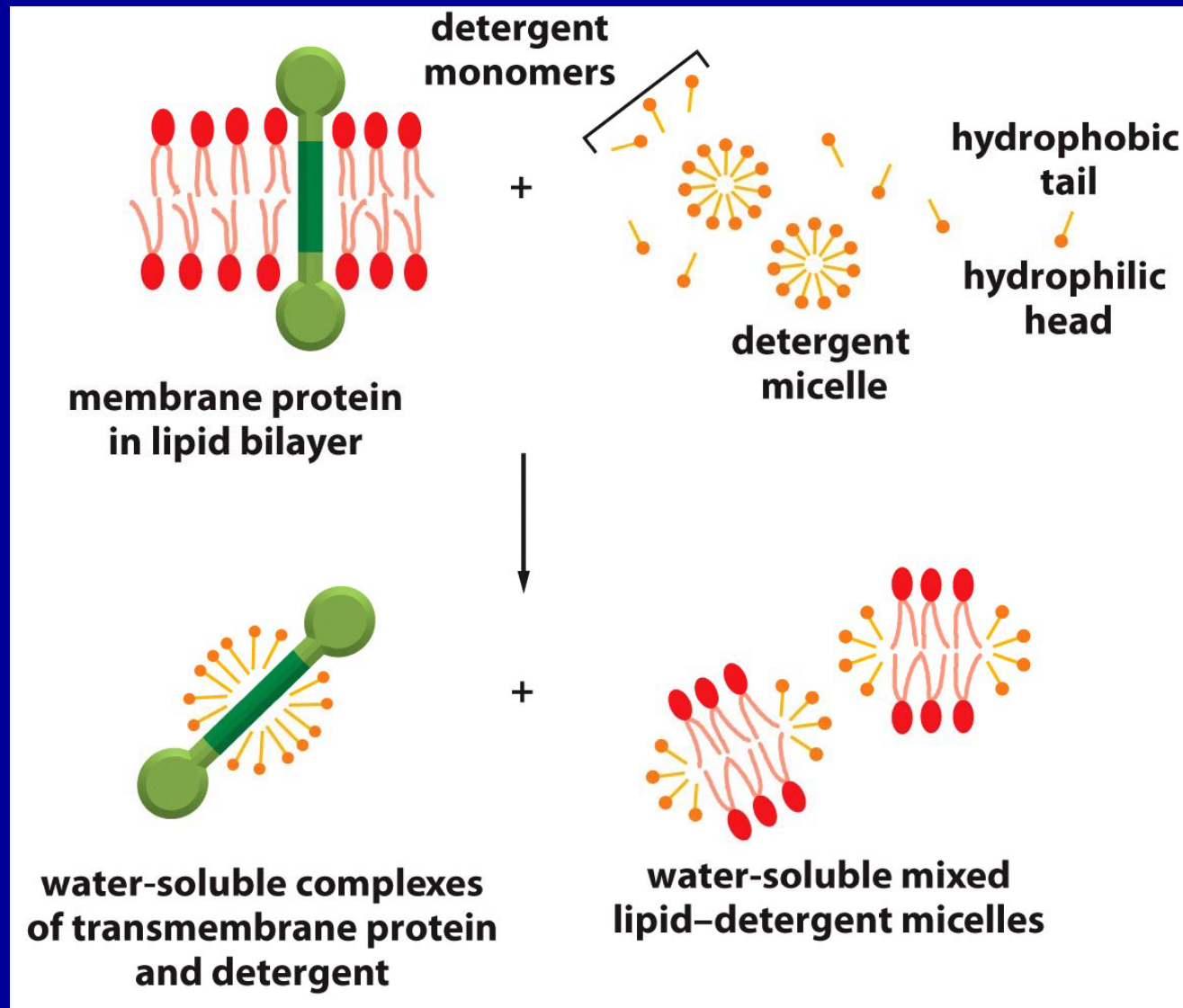

# B. Disrupting Membranes

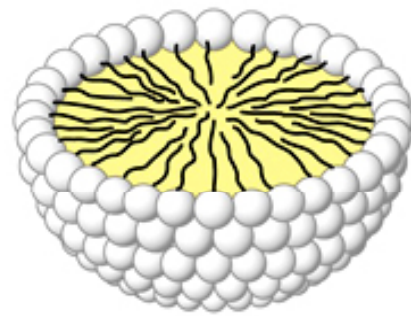

Micelle

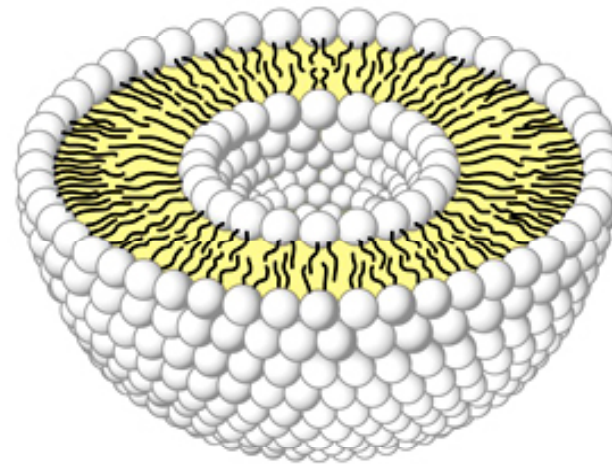

Liposome

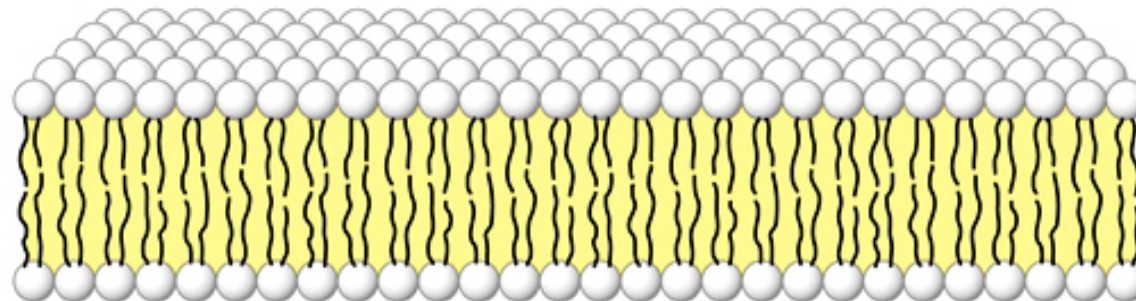

Phospholipid bilayer

# B. Disrupting Membranes

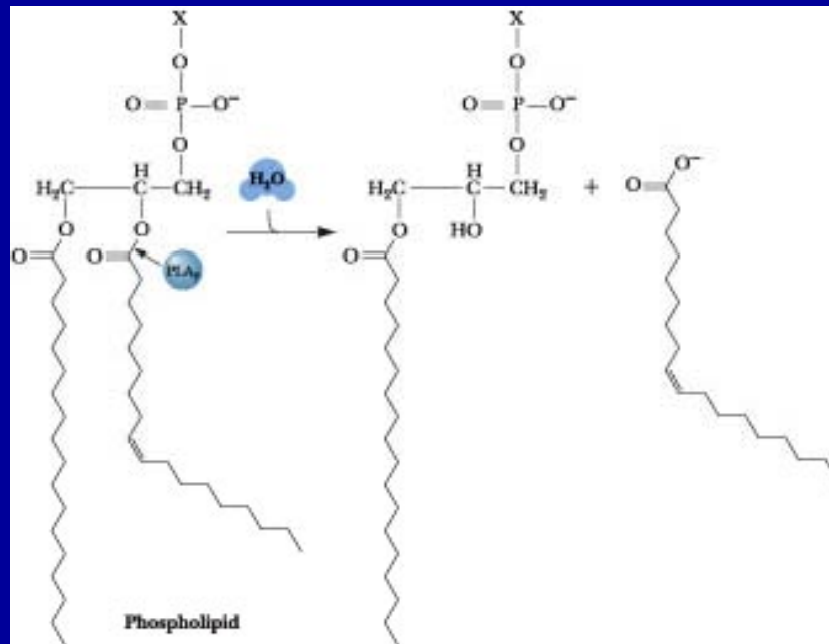

Phospholipases: RBCs...



## C. Animal Cell Adhesion

- **Tight junctions** prevent passage of molecules through space around cells, and define functional regions of the plasma membrane by restricting migration of membrane proteins over the cell surface.
- **Desmosomes** allow cells to adhere strongly to one another.
- **Gap junctions** provide channels for chemical and electrical communication between cells.

# Exploring Intercellular Junctions in Animal Tissues

Tight junctions prevent fluid from moving across a layer of cells

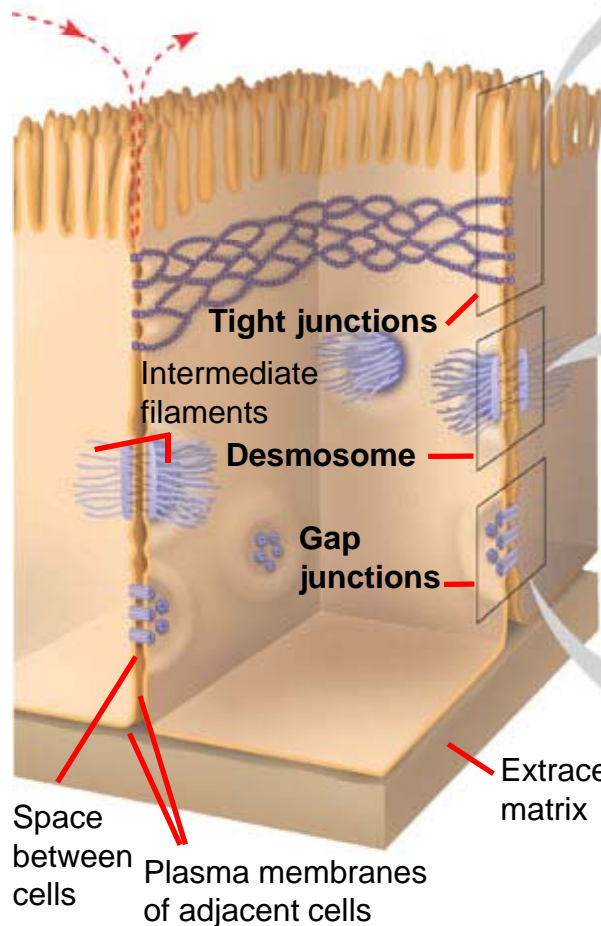

Tight junction



0.25 μm

## TIGHT JUNCTIONS

At **tight junctions**, the membranes of neighboring cells are very tightly pressed against each other, bound together by specific proteins. Forming continuous seals around the cells, tight junctions prevent leakage of extracellular fluid across a layer of epithelial cells.

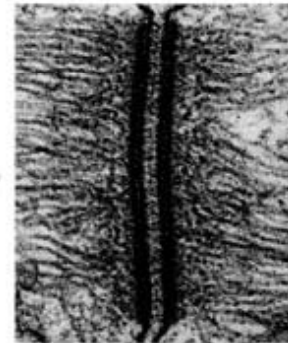

1 μm

## DESMOSOMES

**Desmosomes** (also called *anchoring junctions*) function like rivets, fastening cells together into strong sheets. Intermediate filaments made of sturdy keratin proteins anchor desmosomes in the cytoplasm.

Gap junction



0.1 μm

## GAP JUNCTIONS

**Gap junctions** (also called *communicating junctions*) provide cytoplasmic channels from one cell to an adjacent cell. Gap junctions consist of special membrane proteins that surround a pore through which ions, sugars, amino acids, and other small molecules may pass. Gap junctions are necessary for communication between cells in many types of tissues, including heart muscle and animal embryos.

# Exploring Intercellular Junctions in Animal Tissues

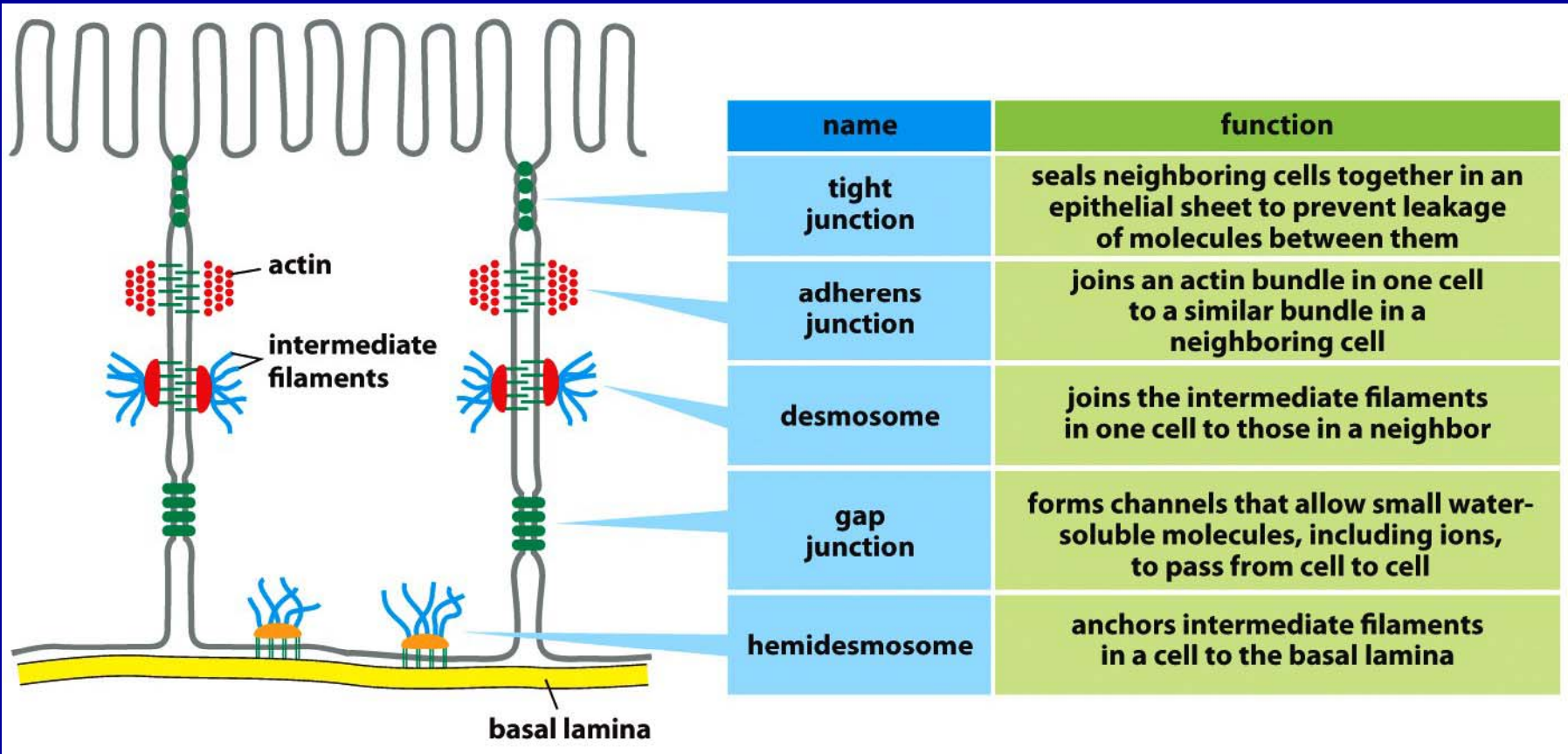

## D. Passive Processes of Membrane Transport

- Substances can diffuse passively across a membrane by: unaided diffusion through the phospholipid bilayer, facilitated diffusion through protein channels, or by means of a carrier protein.

## 5.1 *Membrane Transport Mechanisms*

	SIMPLE DIFFUSION	FACILITATED DIFFUSION	ACTIVE TRANSPORT
Direction	With concentration gradient	With concentration gradient	Against concentration gradient
Energy source	Concentration gradient	Concentration gradient	ATP hydrolysis
Membrane protein required?	No	Yes	Yes
Specificity	Not specific	Specific	Specific

## D. Passive Processes of Membrane Transport

- Solutes diffuse across a membrane from a region with a greater solute concentration to a region of lesser. Equilibrium is reached when the concentrations are identical on both sides.

## EXPERIMENT

**Question:** Does diffusion lead to uniform distribution of solutes?

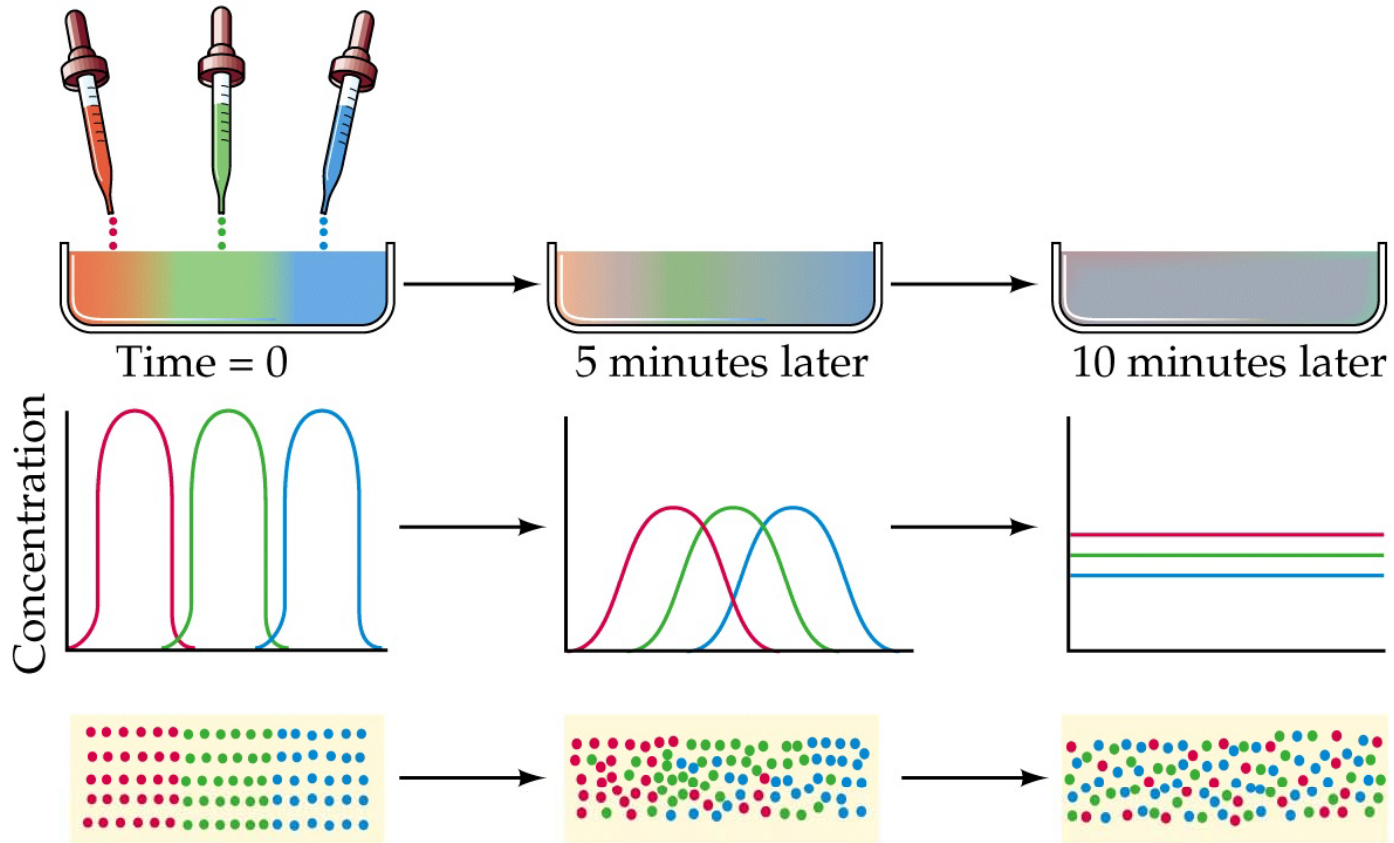

## D. Passive Processes of Membrane Transport

- The rate of simple diffusion of a solute across a membrane is directly proportional to the concentration gradient across the membrane. A related important factor is the lipid solubility of the solute.
- In osmosis, water will diffuse from a region of its higher concentration (low concentration of solutes) to a region of its lower concentration (higher concentration of solutes).



*Osmosis is the movement of water across a semipermeable membrane*

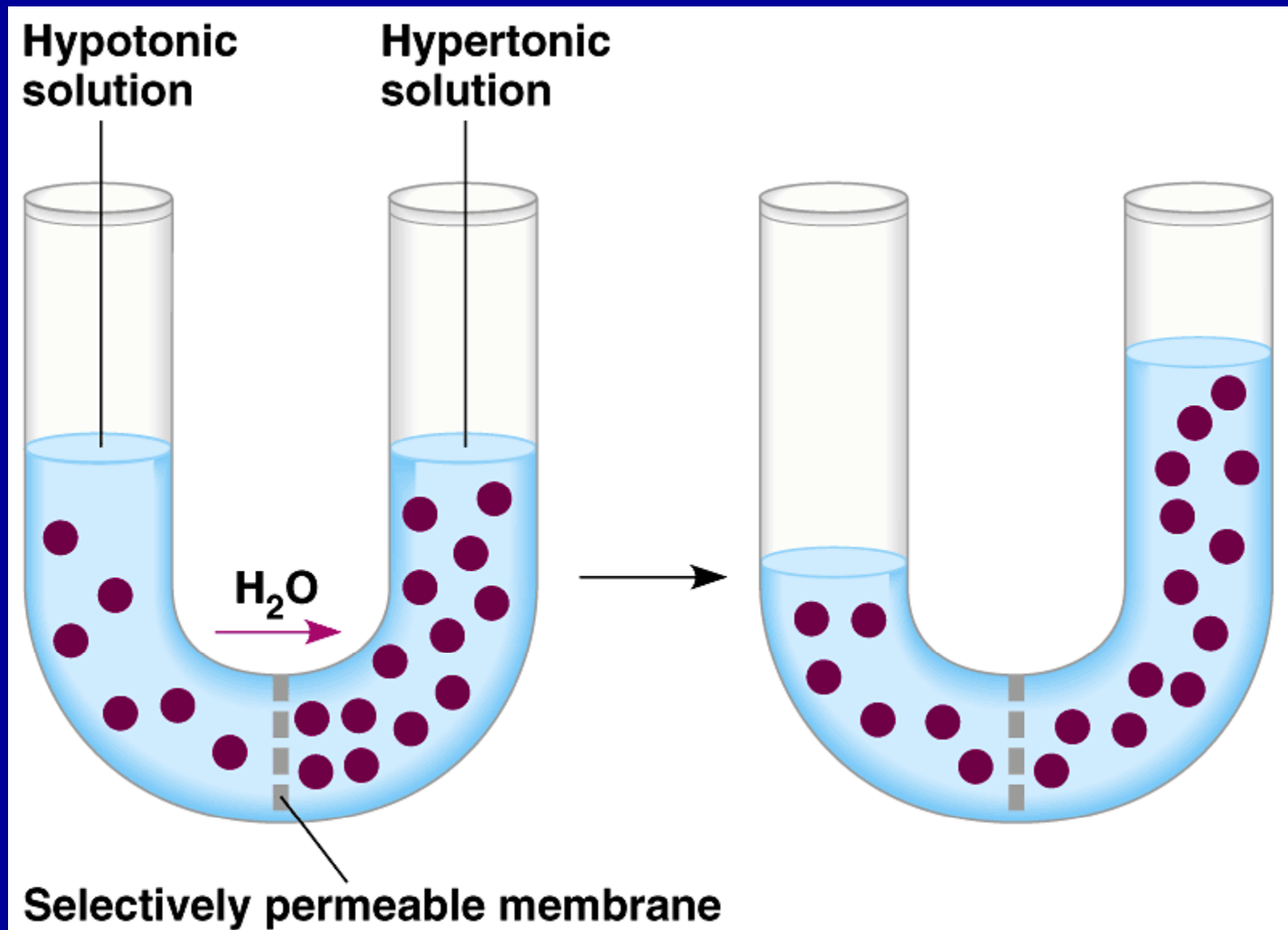

# D. Passive Processes of Membrane Transport

- Small molecules can move across the lipid bilayer by simple diffusion.
- The more lipid-soluble the molecule, the more rapidly it diffuses.
- An exception to this is water, which can pass through the lipid bilayer more readily than its lipid solubility would predict.
- Polar and charged molecules such as amino acids, sugars, and ions do not pass readily across the lipid bilayer.

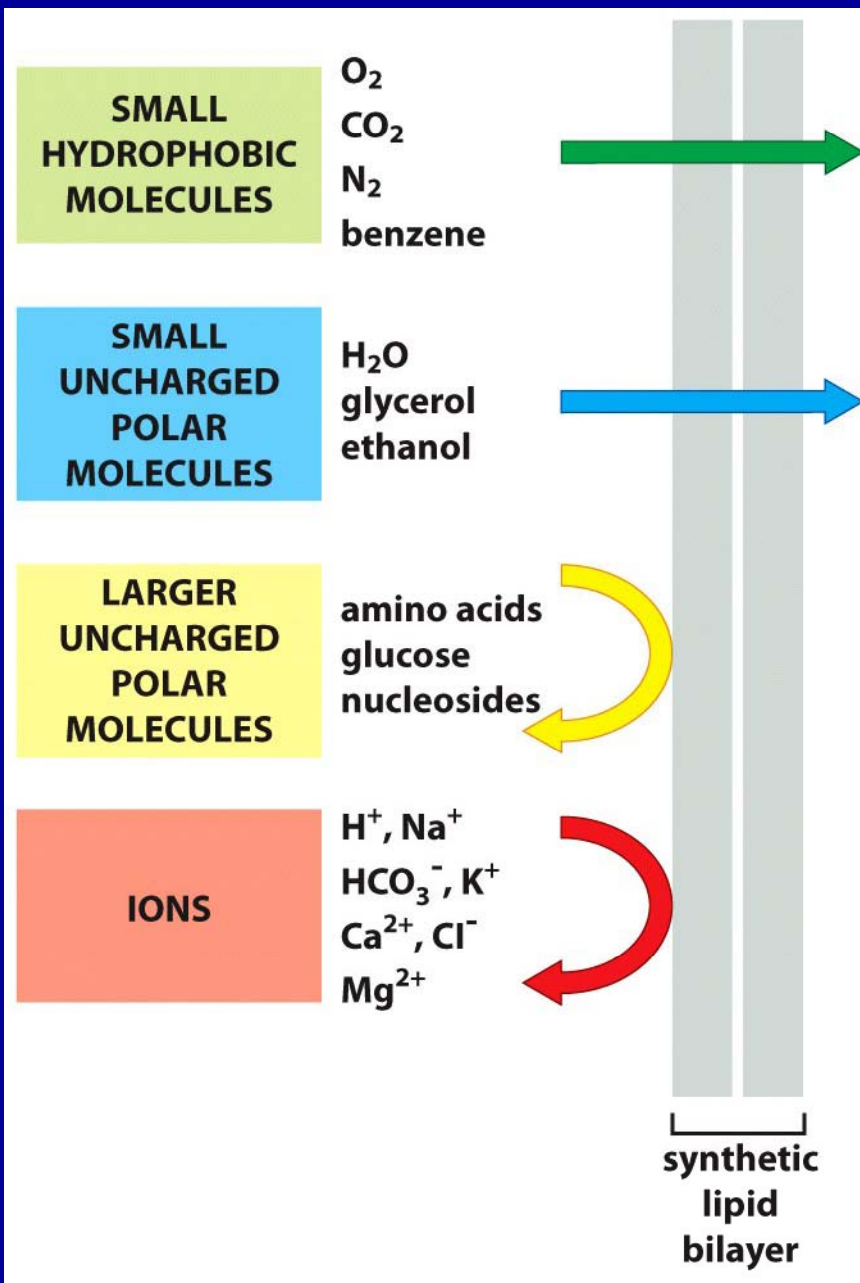

Semi-permeable  
Even with respect  
to diffusion

# Factors affecting permeability: degree of saturation

Lipid bilayer  
with **no**  
unsaturated  
fatty acids

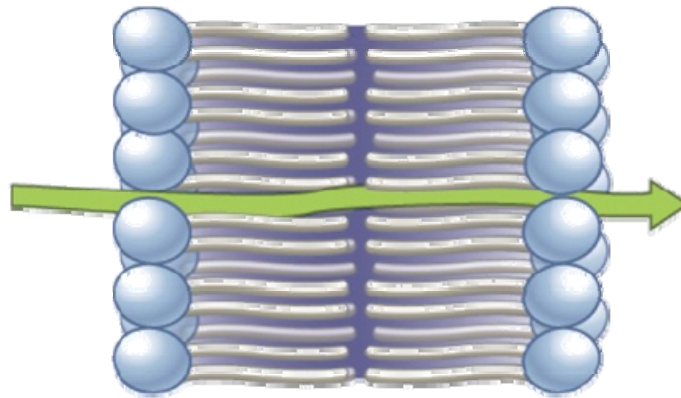

**Lower**  
permeability

Lipid bilayer  
with **many**  
unsaturated  
fatty acids

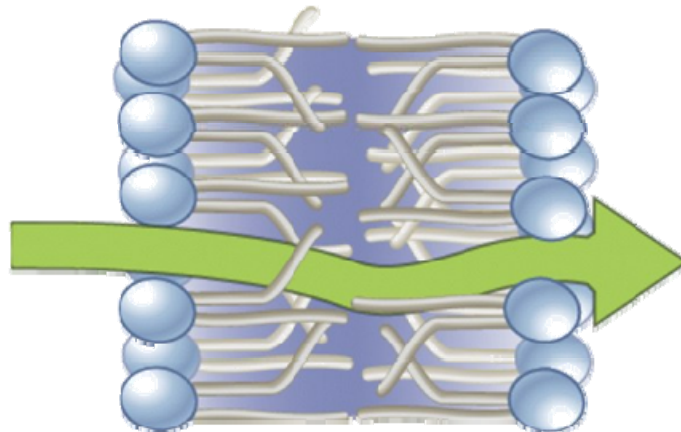

**Higher**  
permeability

## D. Passive Processes of Membrane Transport

- In hypotonic solutions, cells tend to take up water while in hypertonic solutions, they tend to lose it. Animal cells must remain isotonic to the environment to prevent destructive loss or gain of water.

# Osmosis Modifies the Shapes of Cells

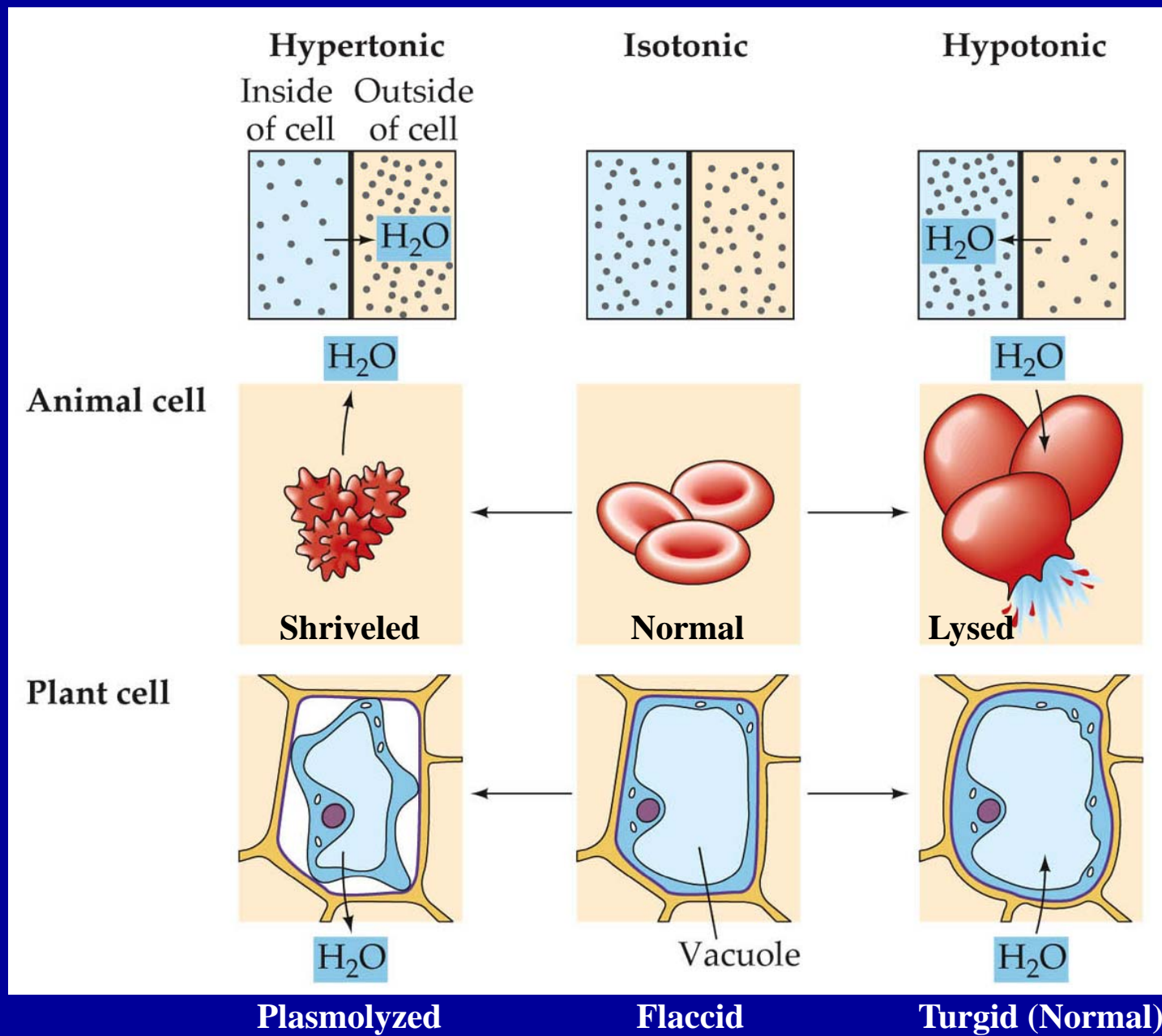

## D. Passive Processes of Membrane Transport

- The cell walls of plants and some other organisms prevent cells from bursting under hypotonic conditions. Turgor pressure develops under these conditions and keeps plants upright and stretches the cell wall during cell growth.

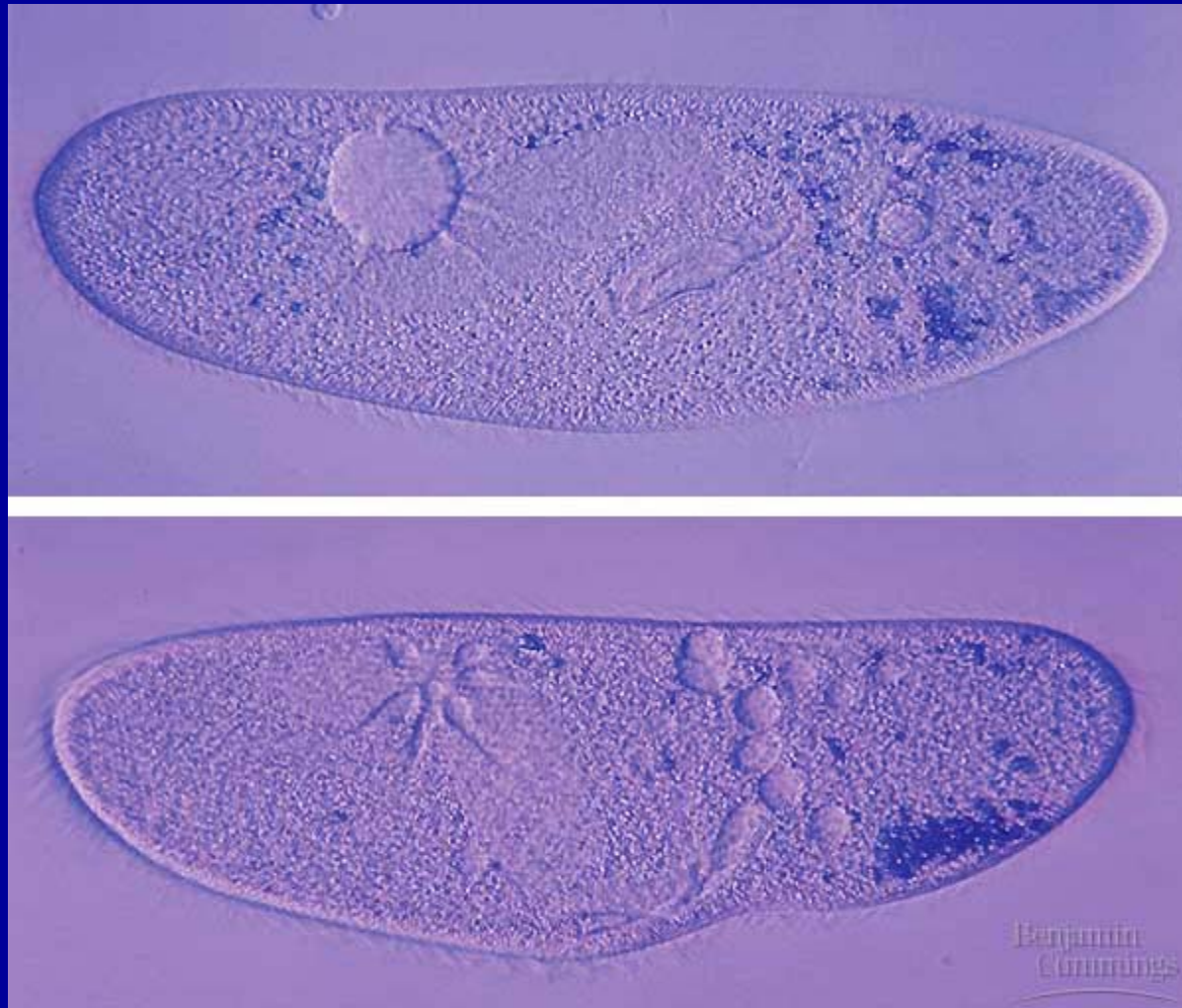

A *Paramecium* (or any organism living in a hypotonic solution) has a special problem. Water tends to move into the cells and swell and burst them. *Paramecium* has a particular structure, called a contractile vacuole, which constantly pumps water outside of the cell, and thus reduces pressure upon the membrane.



## D. Passive Processes of Membrane Transport

- Channel proteins and carrier proteins function in facilitated diffusion.
- Rem: Polar and charged molecules such as amino acids, sugars, and ions do not pass readily across the lipid bilayer.

# *A Gate Channel Protein Opens in Response to a Stimulus*

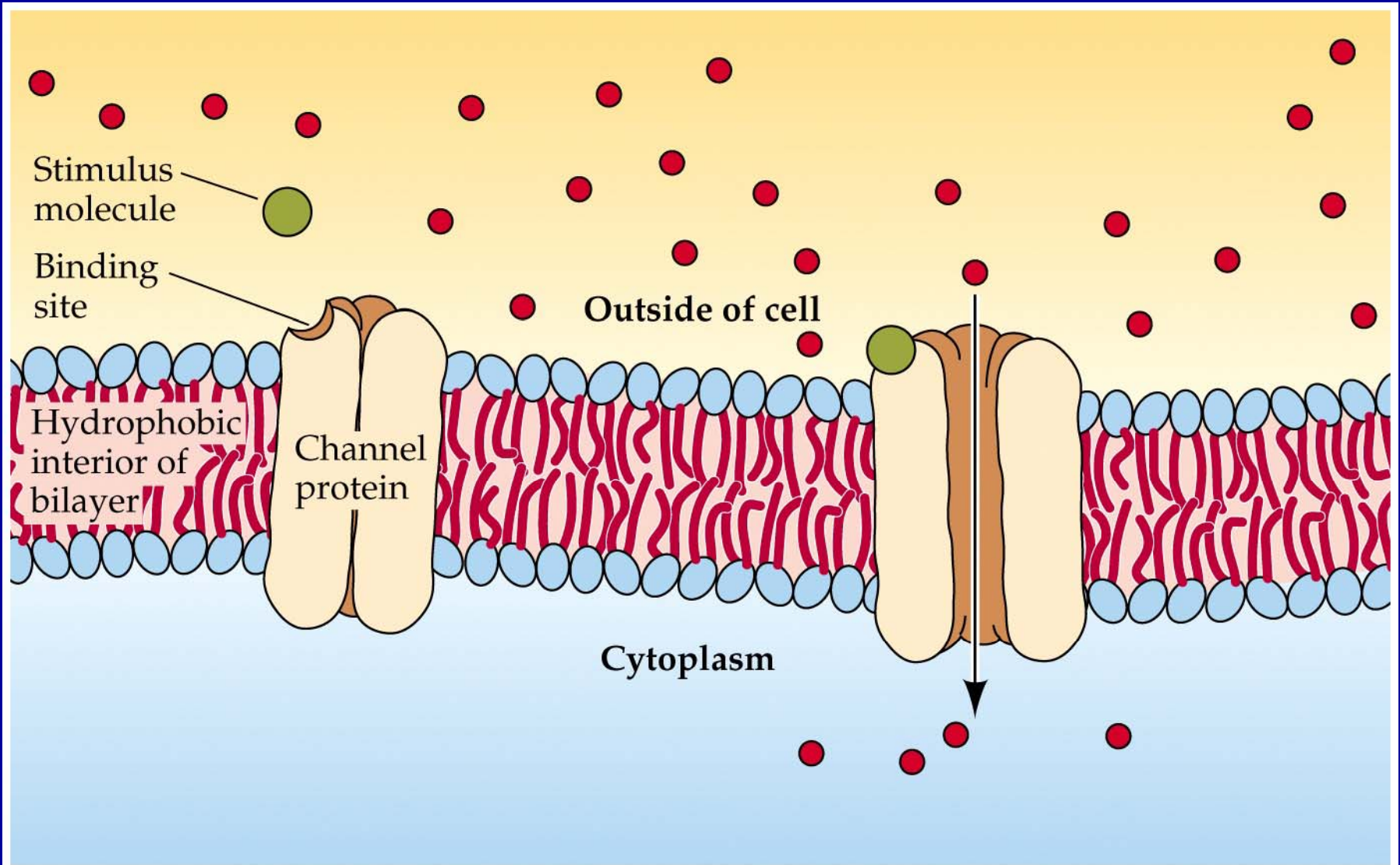

## *A Carrier Protein Facilitates Diffusion*

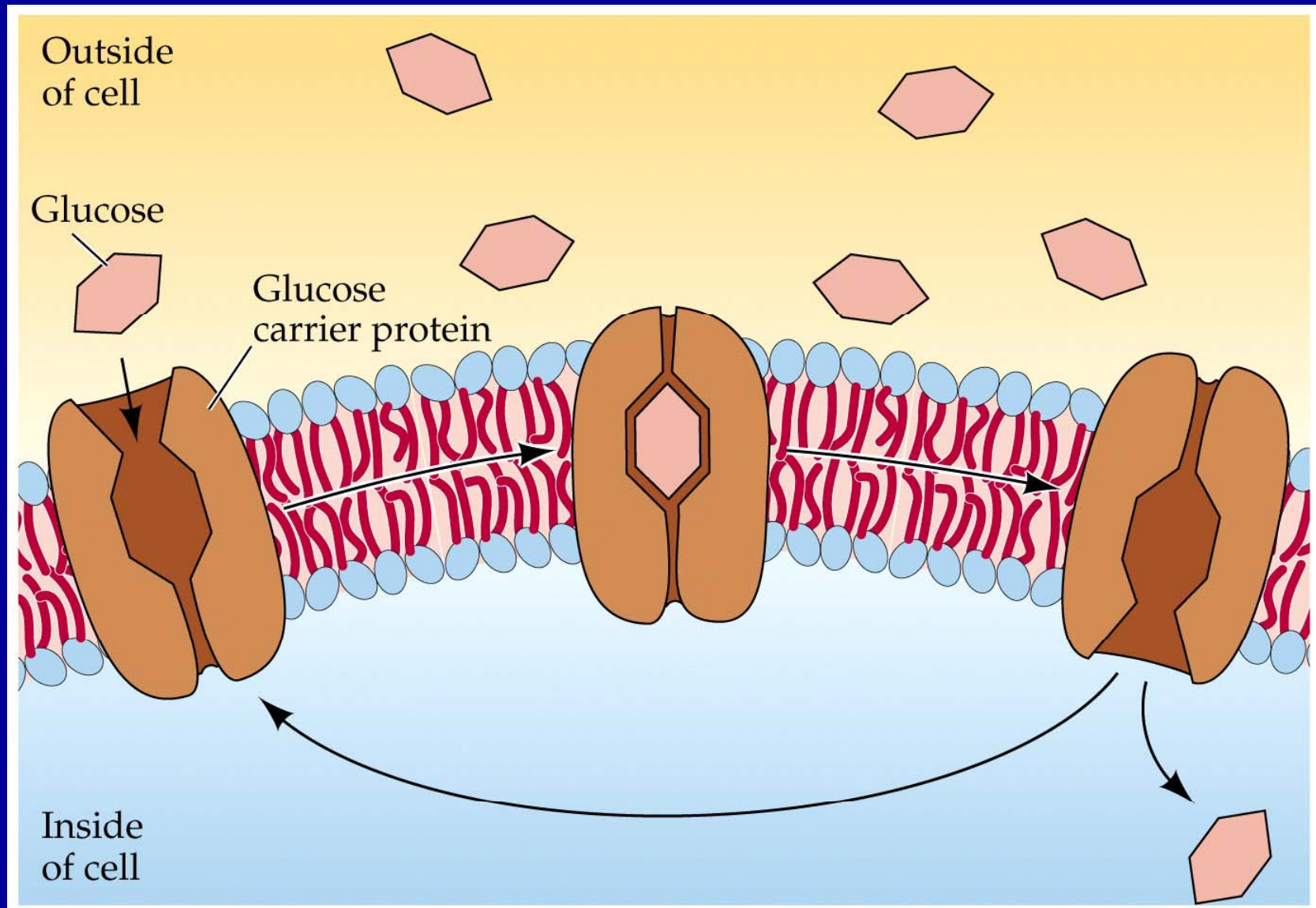

## D. Passive Processes of Membrane Transport

- The rate of carrier-mediated facilitated diffusion is at maximum when solute concentration saturates the carrier proteins so that no rate increase is observed with further solute concentration increase.

# E. Active Transport

- Active transport requires energy to move substances across a membrane AND against a concentration gradient.

# E. Active Transport

- Three different protein-driven systems are involved in active transport:
  - ◆ **Uniport** transporters move a single type of solute, such as calcium ions, in one direction.
  - ◆ **Symport** transporters move two solutes in the same direction.
  - ◆ **Antiport** transporters move two solutes in opposite directions, one into the cell, and the other out of the cell.

## *Three Types of Proteins for Active Transport*

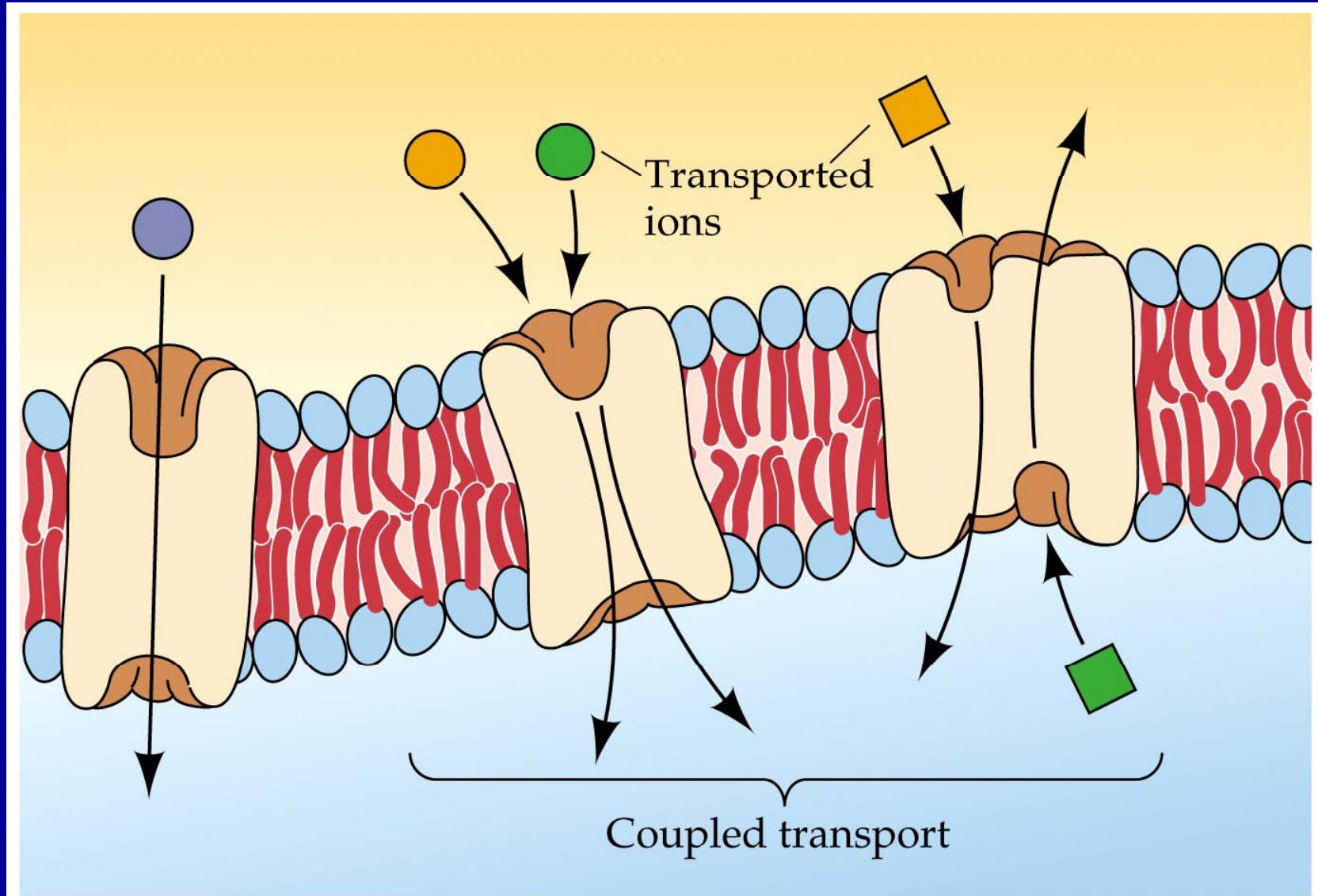

# E. Active Transport

- In primary active transport, energy from the hydrolysis of *ATP* is used to move ions into or out of cells against their concentration gradients.



# Primary Active Transport: The Sodium-Potassium Pump

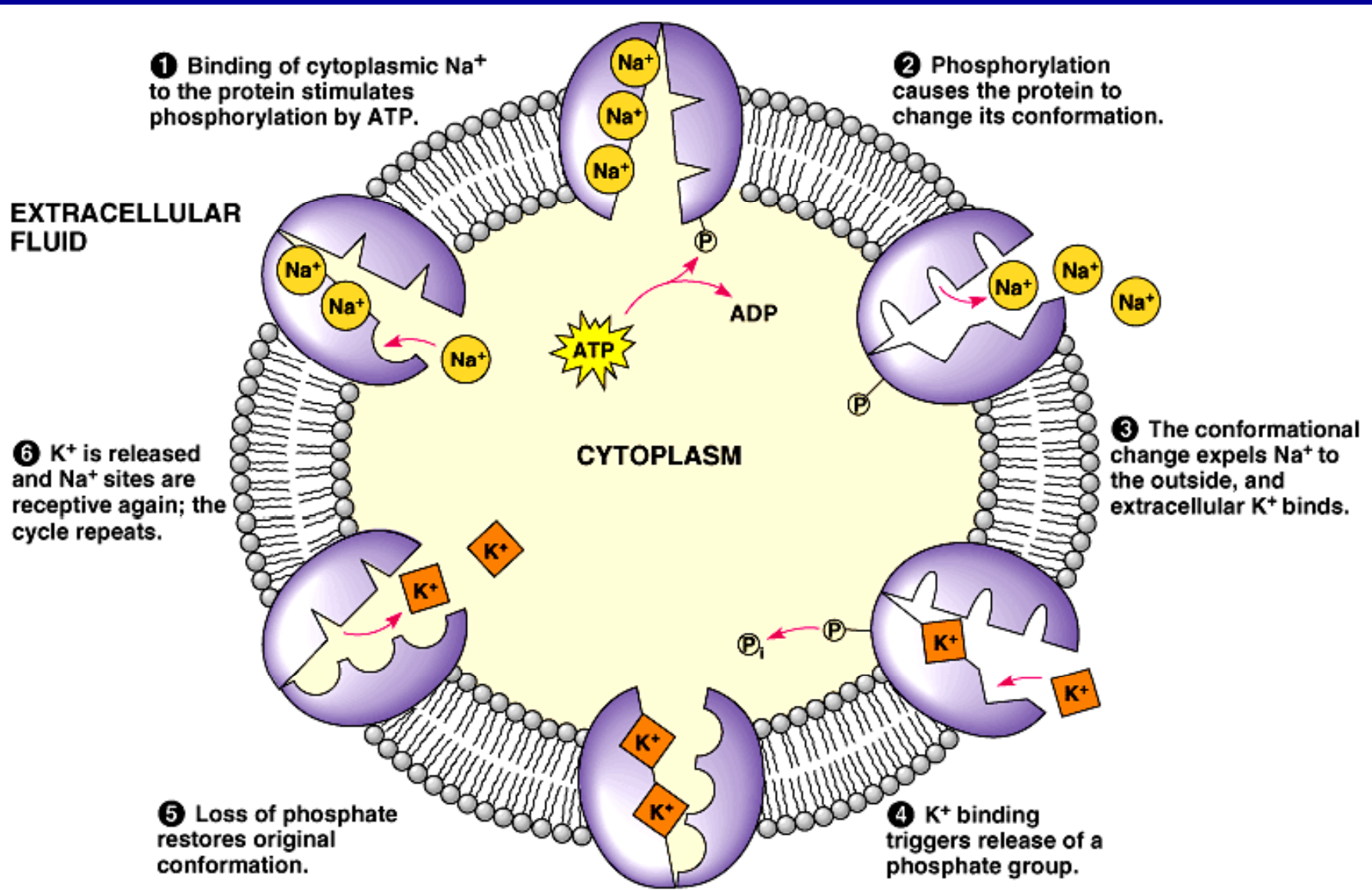

# Na<sup>+</sup> K<sup>+</sup> pump - an ATPase

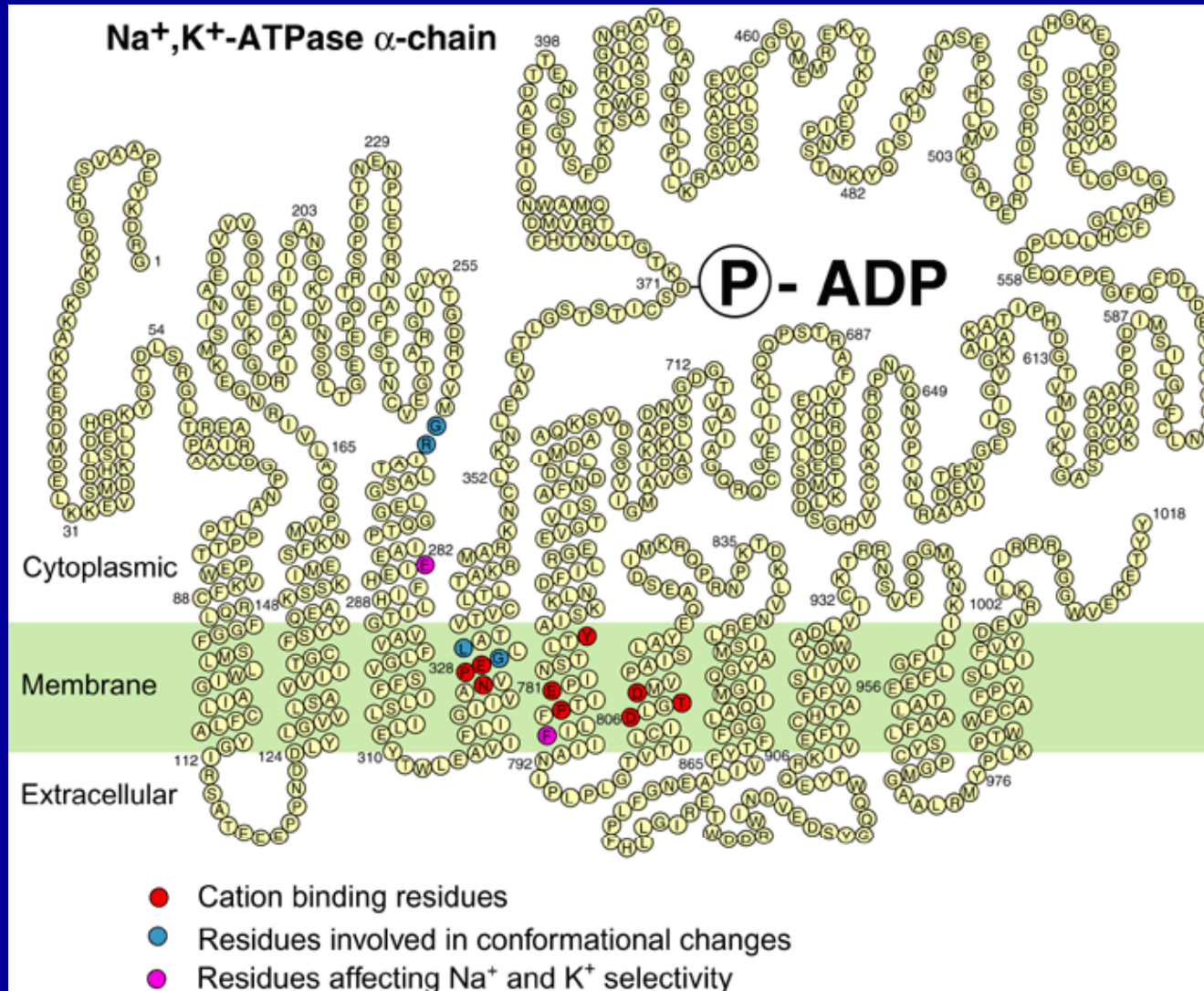

# E. Active Transport

- Secondary active transport couples the passive movement of one solute with its concentration gradient to the movement of another solute against its concentration gradient. Energy from ATP is used indirectly to establish the concentration gradient resulting in movement of the first solute.

## Secondary Active Transport

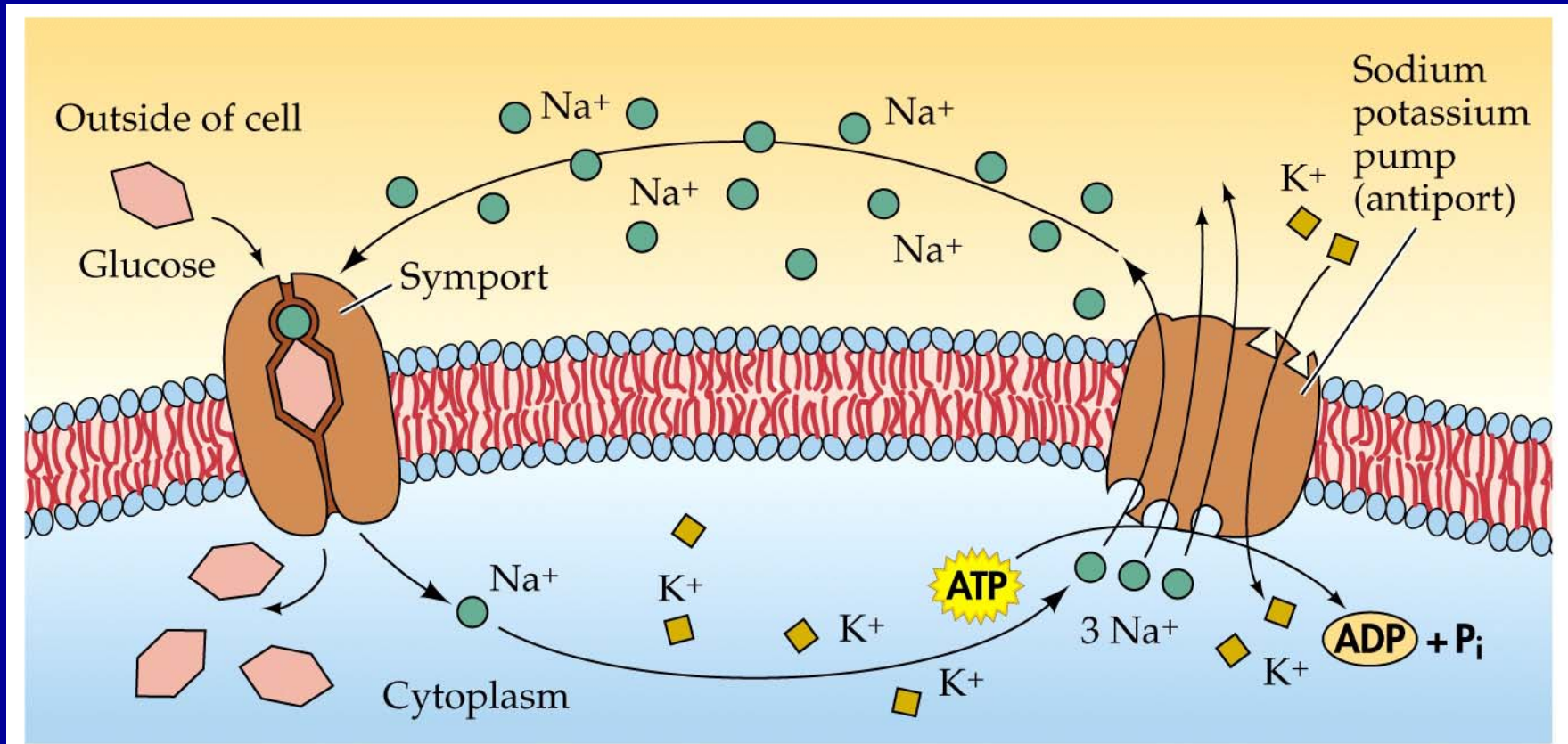

An example is the symport system found in intestinal cells, which moves glucose up its concentration gradient, while moving sodium ions down its ion concentration gradient.

# F. Endocytosis and Exocytosis

- Endocytosis transports macromolecules, large particles, and small cells into eukaryotic cells by means of engulfment and by vesicle formation from the plasma membrane.
- There are three types of endocytosis: phagocytosis, pinocytosis, and receptor-mediated endocytosis.

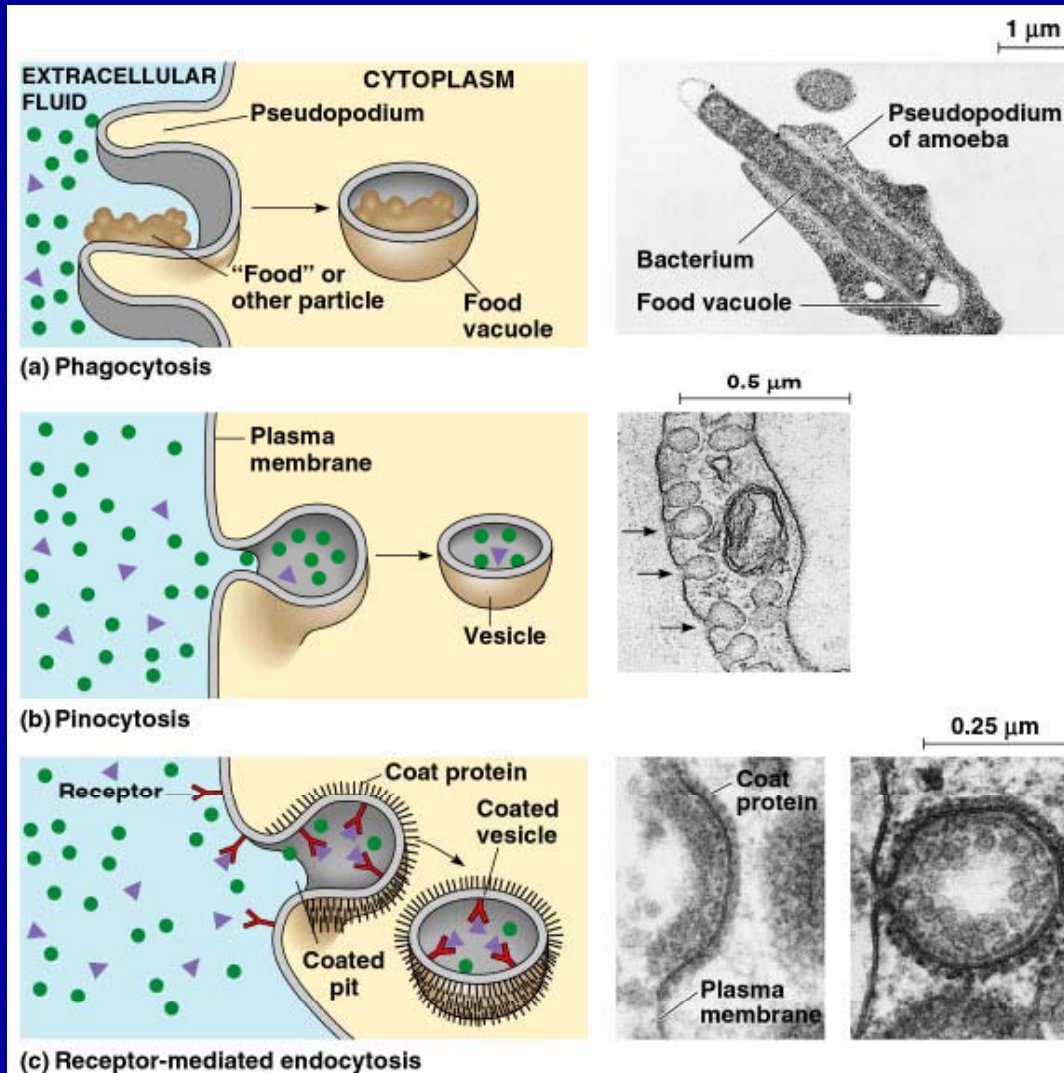

Phagocytosis and pinocytosis are two forms of endocytosis (phagocytosis moves particles into the cell and pinocytosis moves solubilized materials). Receptor-mediated endocytosis is a process that moves materials into the cell as a result of specific binding to surface proteins (cholesterol is a particular example).

# F. Endocytosis and Exocytosis

- In receptor-mediated endocytosis, a specific membrane receptor binds to a particular macromolecule.
- Receptor proteins are exposed on the outside of the cell in regions called coated pits.
- Clathrin molecules form the "coat" of the pits.
- Coated vesicles form with the macromolecules trapped inside.

## *Formation of a Coated Vesicle*

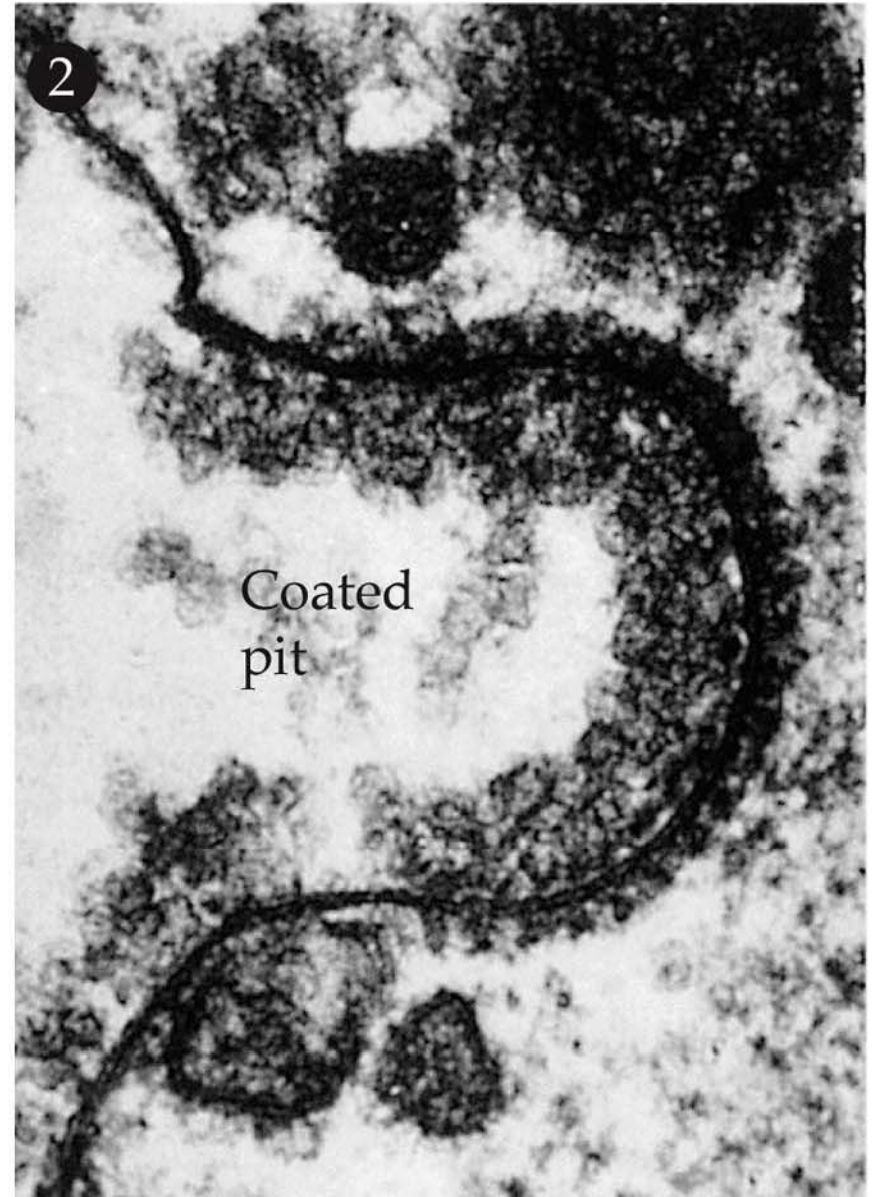
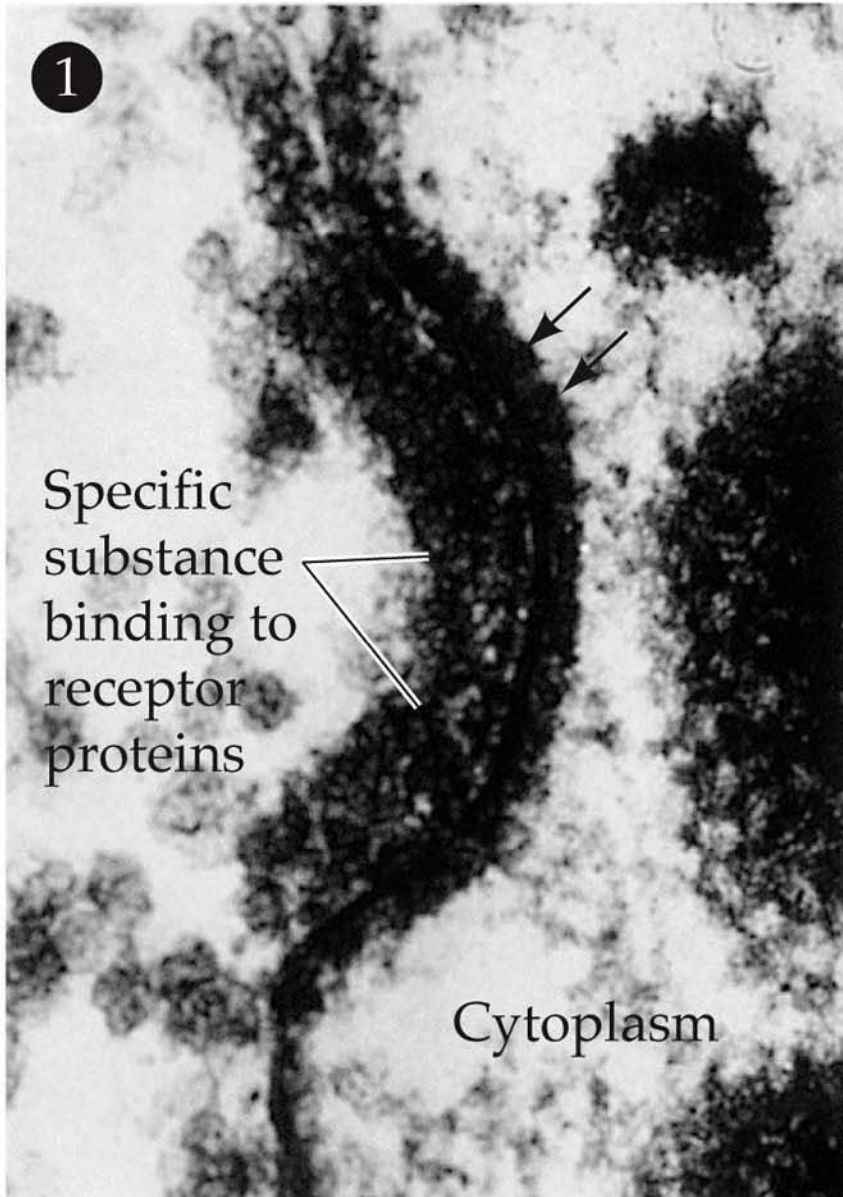



## *Formation of a Coated Vesicle*

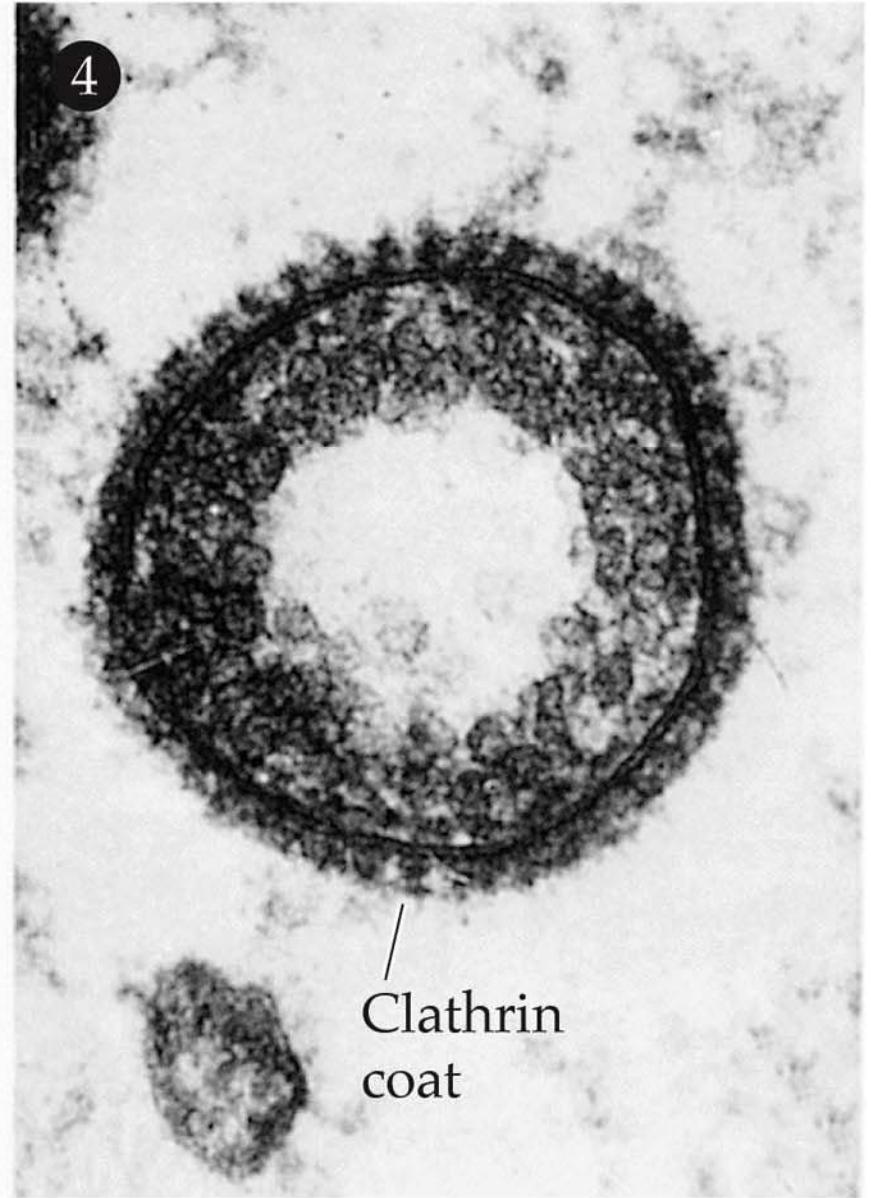
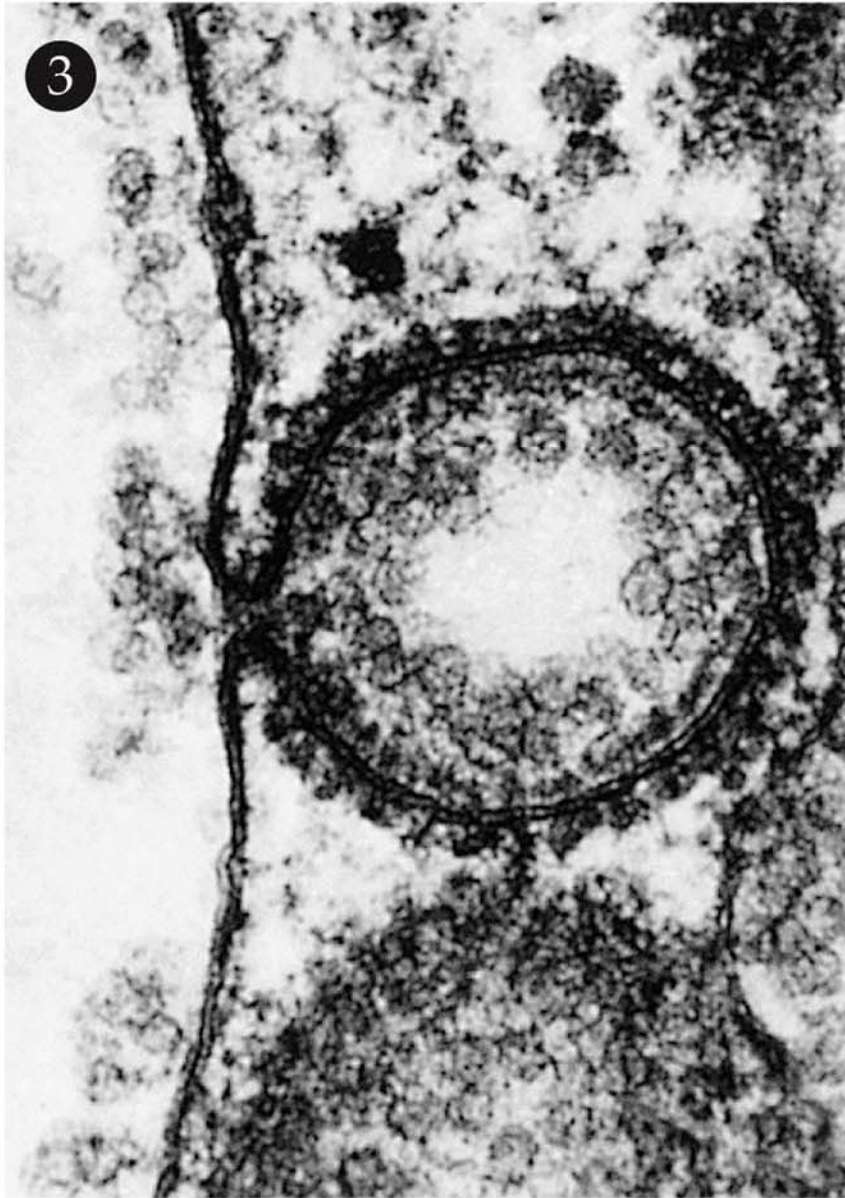

# Clathrin-coated vesicles transport selected cargo molecules

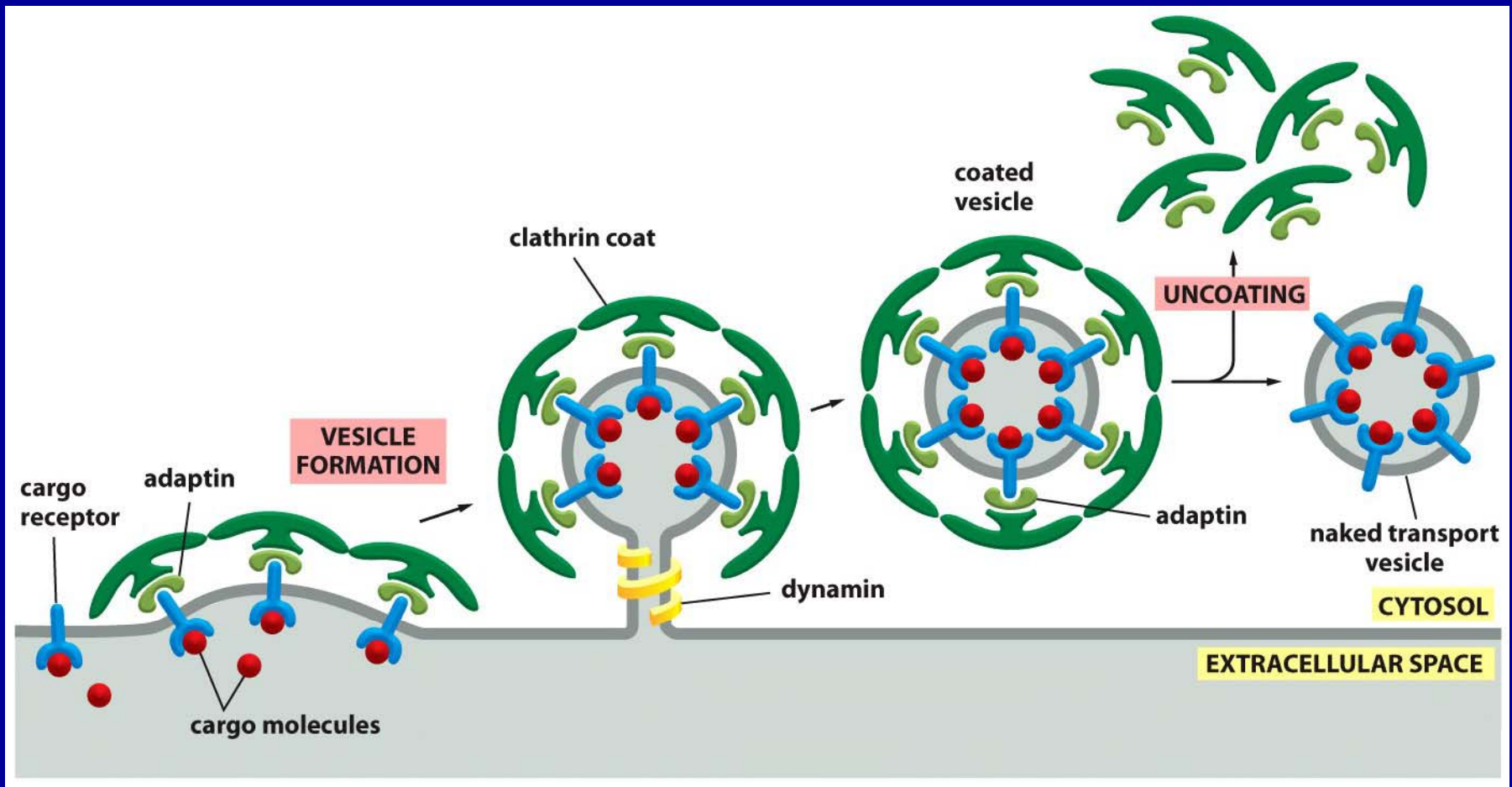

# F. Endocytosis and Exocytosis

- In exocytosis, materials in vesicles are secreted from the cell when the vesicles fuse with the plasma membrane.
- Vesicles are spherical arrays of phospholipids that can fuse with (exocytosis) and withdraw from (endocytosis) membranes.

# Mechanisms for Exocytosis

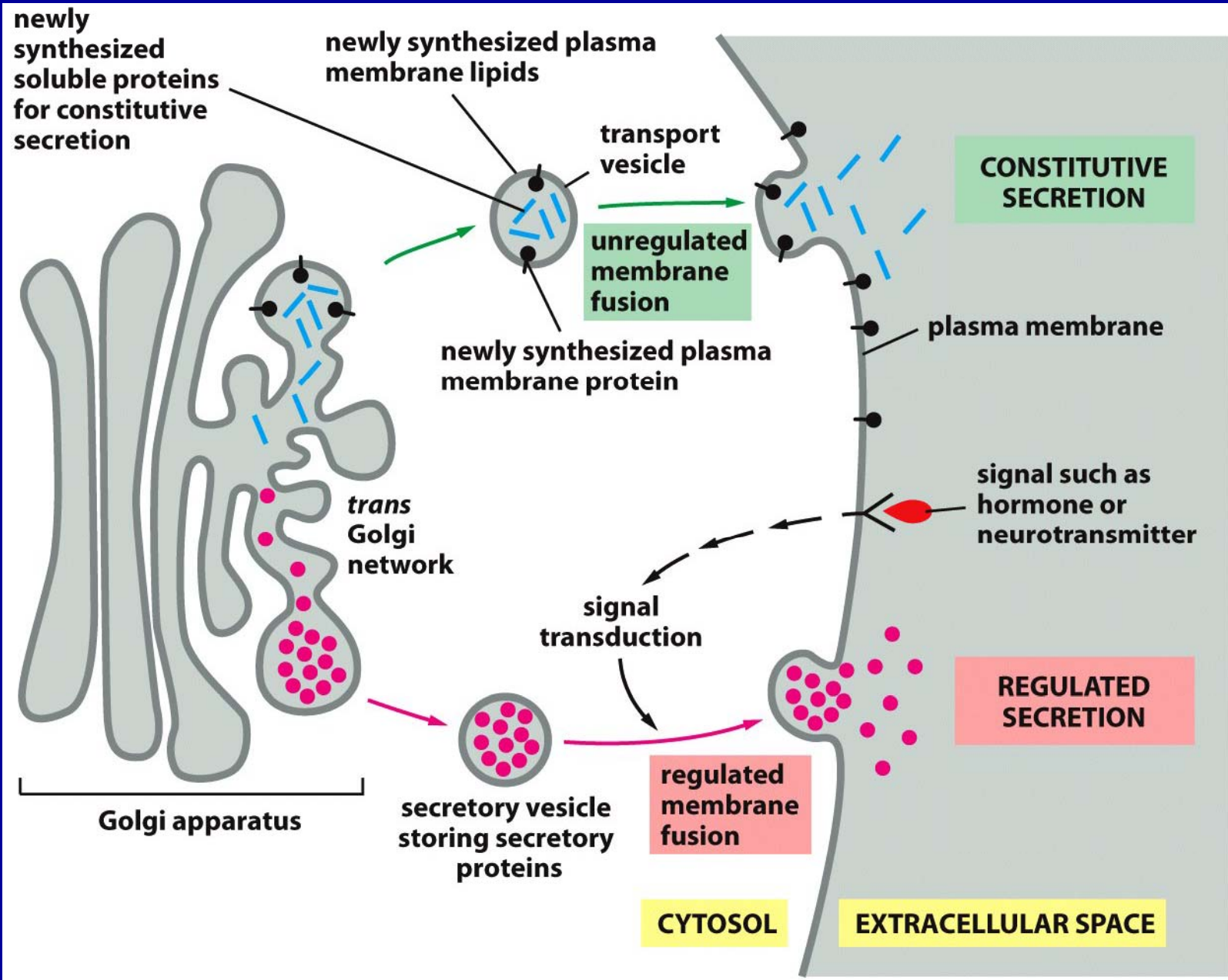

## Pancreas Secretory Vesicles containing Insulin

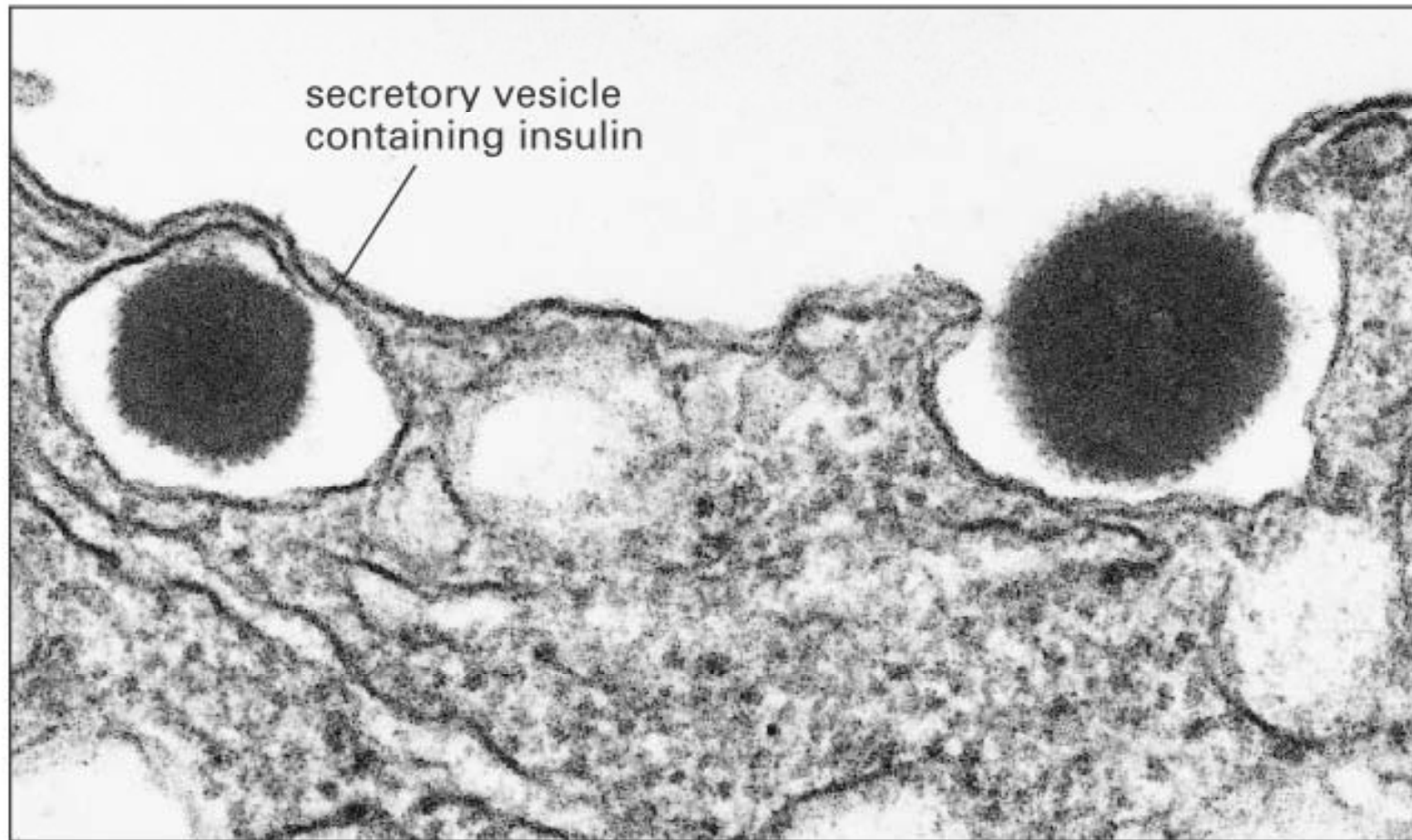

0.2  $\mu\text{m}$